

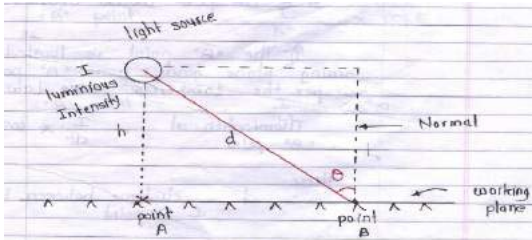

Important suggestions to examiners:

- 1) The answers should be examined by key words and not as word-to-word as given in the model answer scheme.
- 2) The model answer and the answer written by candidate may vary but the examiner may try to assess the understanding level of the candidate.
- 3) The language errors such as grammatical, spelling errors should not be given more importance. (Not applicable for subject English and communication skills)
- 4) While assessing figures, examiner may give credit for principle components indicated in a figure. The figures drawn by candidate and model answer may vary. The examiner may give credit for any equivalent figure drawn.
- 5) Credits may be given step wise for numerical problems. In some cases, the assumed constant values may vary and there may be some difference in the candidate's answers and model answer.
- 6) In case some questions credit may be given by judgment on part of examiner of relevant answer based on candidate understands.
- 7) For programming language papers, credit may be given to any other program based on equivalent concept.

Q.1 A)	Attempt any THREE of the following:	12 Marks
a)	State and explain Lambert's cosine law of illumination.	
Ans:	<p>Lambert's cosine law of illumination: (State: 2 Mark & Explanation: 2 Mark)</p> <p>This law states that “the illumination E at any point on a surface is directly proportional to the cosine of the angle between the normal at that point and the line of flux.</p> <p>Illumination at B point = $I/d^2 \times \cos \theta$</p>  <p style="text-align: right;">or equivalent figure</p> <p style="text-align: center;">OR</p> <p>Lambert's Lambert's Cosine Law:</p> <p>According to this law, Illumination at any point on a surface is proportional to the cosine of the angle between the normal at that point and the direction of luminous flux</p>  <p style="text-align: center;"><small>Fig. 6.3 Lambert's cosine law.</small></p> <p style="text-align: right;">or equivalent figure</p>	

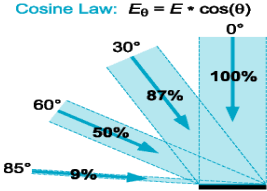

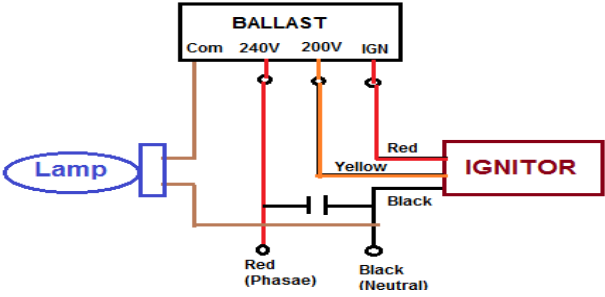
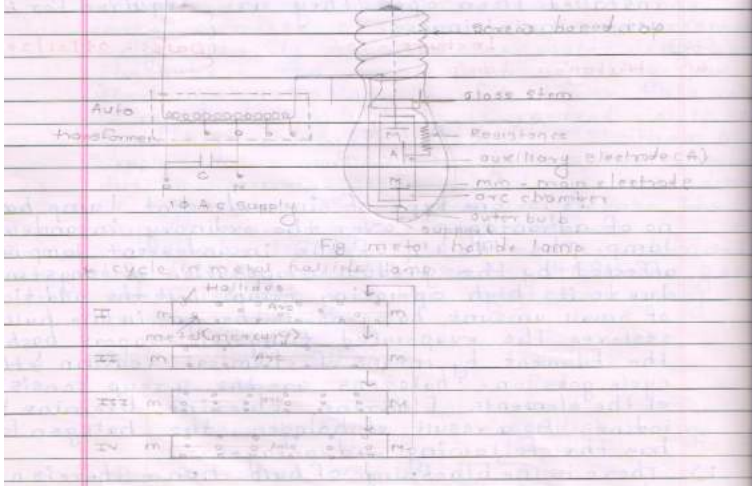
b)	Explain construction of metal halide lamp with sketch.
Ans:	<p>Metal Halide lamp: (Construction : 2 Mark & Diagram: 2 Mark)</p> <p style="text-align: center;">Circuit for Ballast-Ignitor-Capacitor-Lamp</p>  <p>Construction is similar to mercury lamp.</p> <ul style="list-style-type: none"> ➤ MH lamps consist of an arc tube (inner) enclosed by an outer tube. ➤ Vacuum is created between the inner & outer glass tube to prevent heat loss. ➤ The inner arc tube contains the electrodes and various metal halides, along with mercury and inert gases that make up the mix. ➤ MH lamp has three electrodes – two for maintaining the arc and a third internal starting electrode ➤ OR Pulse-start MH lamps do not have a starting electrode. An igniter in the pulse start system delivers a high voltage pulse (typically 3 to 5 kilovolts) directly across the lamp's operating electrodes to start the lamp ➤ IT require a ballast to give high voltage at starting to produce the arc ➤ The capacitor is used to improve the power factor. <p style="text-align: center;">OR Student may Wright</p> <p>Construction:</p>  <p style="text-align: right;">or equivalent figure</p>



Constructional it is similar to mercury lamp. Its discharge tube (inter tube) contain a drop of mercury which is named as 'metal' and halides such as thallium, indium or sodium, So the lamp is named as metal halide lamp.

Its operation is some similar to the mercury lamp. An arc is established between one main electrode & auxiliary electrode through argon gas and then regular discharge takes place between two main electrodes through mercury vapour. The light is produced from an excited mercury vapour and the products of dissociation of halide.

Diagram:

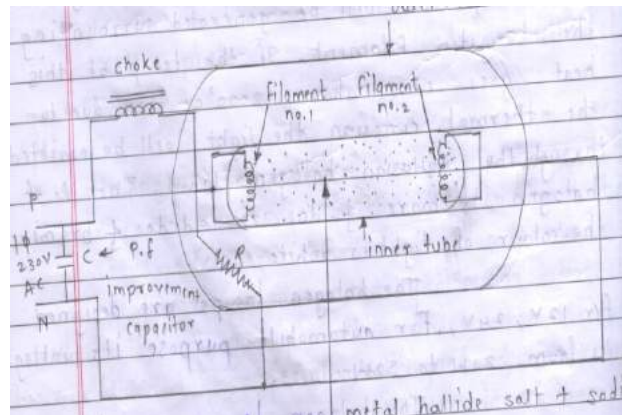

or equivalent figure

The halide cycle in metal halide lamp.

- Metal (mercury) atoms move from electric arc towards the tube wall where the halides are present.
- Near the wall, the temperature & vapors pressure allows the metals & halides to form a stable molecule which is known as metal halide molecules.
- When metal halide approaches the arc, molecules break apart.
- The halide move towards the wall and metals are excited and give out energy in the form of light.
- When enough metal atoms or loss during the operation the lamp fails.
- The outer glass may or may not be phosphor coated from inside.
- Electronic or auto transformer type ballast is used initiate the arc and to control the current,
- The capacitor is used to improve the power factor.
- The power ratings of lamp are from 175 watts to 1000 watts.
- The life is 2000 working hours.
- Some metal halides are used in indoor applications and the compact metal halide lamps are used for display and flood light etc.

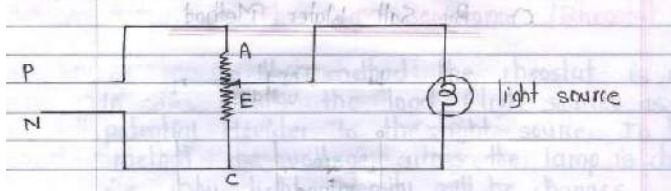
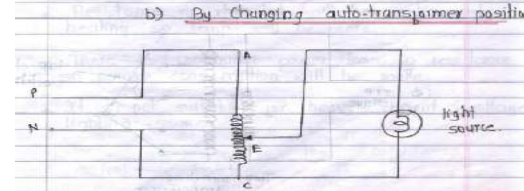
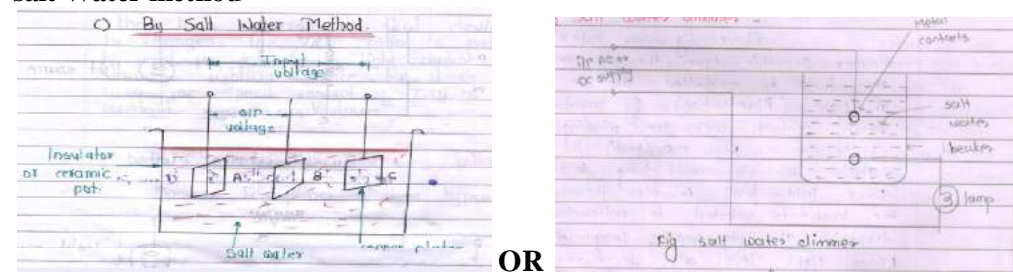

<p>c) Ans:</p>	<p>List the different dimmers used in illumination control. Explain the operation of any one type.</p> <p>Types of Dimmer: - (Types of Dimmer: 2 Mark & Any one types explanation of Dimmer:2 Mark)</p> <p>a) Electrical Dimmer b) Electronic Dimmer</p> <p>a) Electrical dimmer are again classified into - (Any One Explanation Expected)</p> <ol style="list-style-type: none"> 1) Dimmer by using changing resistance (Rheostatic) 2) By using auto transformer 3) By salt water method 4) By two winding transformer tap changing method <p>1) Dimmer by using changing resistance –</p>  <p>➤ In this method as resistance changes output voltage across the light sources changes of that light intensity will be changes.</p> <p>2) By using auto transformer –</p>  <p style="text-align: right;">or equivalent figure</p> <p>➤ As position of dimmer or auto transformer changes output voltages across light source will changes .So that light intensity also changes.</p> <p>3) By salt Water method –</p>  <p style="text-align: center;">OR or equivalent figure</p> <p>➤ As position of rod in immersed position changes output voltage across Light sources will be changes .So that light intensity also will be changes.</p>
----------------	---



4) By two winding transformer tap changing method –

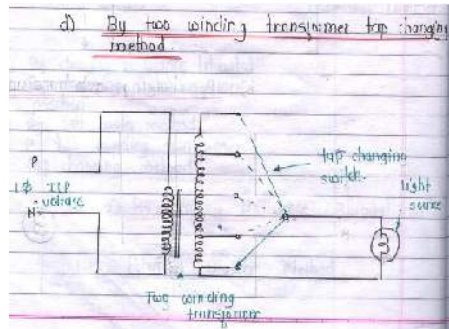

or equivalent figure

- Output voltage across the source depends upon tap position of the two winding.
- Transformer so that light intensity of light sources will be changes.

b) Electronic dimmer:

(Any One Explanation Expected)

1) S.C.R operated dimmer:-

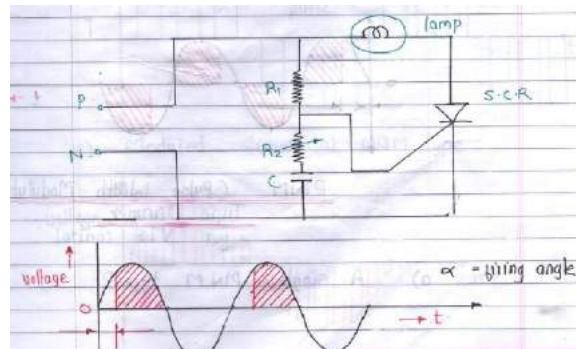

or equivalent figure

In this method firing of S.C.R depends upon R_1 and R_2 and capacitance 'c' so that output voltage across light source can be changed.

2) Triac operated dimmer –

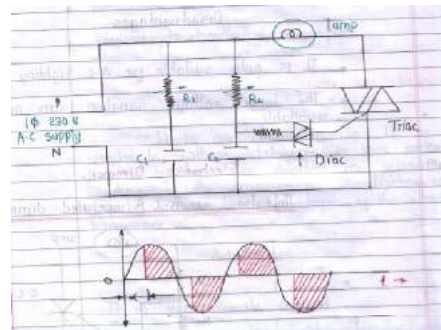

or equivalent figure

- In this method firing of triac depends upon diac and it's controlling circuits. So that output voltage across the light source is controlled to control its intensity.

d)

A hall of 40 ft by 50 ft is to be illuminated to 45 lumen per sq. ft. on working plane. If utilization factor is 0.6 and depreciation factor is 0.8 and source gives an output 10



$$N = \frac{45 \times 2000}{100 \times 10 \times 0.6 \times 0.8}$$

$$N = 187.5 \cong 188 \text{ Nos lamps of } 100\text{watt.} \text{ ----- (1 Mark)}$$

OR

$$\begin{aligned} \text{Total lumens required on working plane} &= \frac{AIW}{C \times D} \text{ ----- (1/2 Mark)} \\ &= \frac{2000 \times 45 \times 1}{0.6 \times 0.8} \end{aligned}$$

$$= 187500 \text{ Lumens -----(1 Marks)}$$

$$\begin{aligned} \text{iii) Total Wattage} &= \frac{\text{Total lumens given out by the lamps}}{\text{lumens efficiency}} \text{ -----(1/2 Marks)} \\ &= \frac{187500}{10} \\ &= 18750 \text{ Watts ----- (1/2Marks)} \end{aligned}$$

$$\begin{aligned} \text{iv) Number of Lamps} &= \frac{\text{Total Wattage}}{\text{Wattage of each lamp}} \text{ -----(1/2 Marks)} \\ &= \frac{18750}{100} \\ &= 187.5 \cong 188 \text{ Nos of lamp} \text{ -----(1 Marks)} \\ \therefore \text{Numbers of lamps} &= 188 \text{ Nos of } 100 \text{ watt} \end{aligned}$$

OR Student Assume Wattage of Lamp = 200 watt

$$\begin{aligned} \text{iv) Number of Lamps} &= \frac{\text{Total Wattage}}{\text{Wattage of each lamp}} \text{ -----(1/2 Marks)} \\ &= \frac{18750}{200} \\ &= 93.75 \cong 94 \text{ Nos of lamp} \text{ -----(1 Marks)} \\ &= 94 \text{ Nos of lamp} \end{aligned}$$



MAHARASHTRA STATE BOARD OF TECHNICAL EDUCATION
(Autonomous)
(ISO/IEC-27001-2005 Certified)

Summer– 2016 Examinations

Subject Code: 17639

Model Answer

Page 8 of 44

Q.1B)	Attempt any ONE of the following :	06 Marks																												
a)	Compare filament lamp and fluorescent lamp on the basis of following : (i) quality of light (ii) capital and running cost (iii) lamp efficiency (iv) life of lamp (v) voltage regulation (vi) lumen output																													
Ans:	(Each Point : 1 Mark)																													
	<table border="1"><thead><tr><th>S.No.</th><th>Points of comparison</th><th>filament Lamp</th><th>Fluorescent Lamp</th></tr></thead><tbody><tr><td>1</td><td>Quality of light</td><td>Good</td><td>Best</td></tr><tr><td>2</td><td>Capital and Running cost</td><td>Capital cost is less and Running cost is more as life is less</td><td>Capital cost is more and Running cost is less as life is more</td></tr><tr><td>3</td><td>Lamp efficiency</td><td>Less (12 to 15 lm/w)</td><td>More (40 to 60 lm/w)</td></tr><tr><td>4</td><td>Lamp Life</td><td>less</td><td>More</td></tr><tr><td>5</td><td>voltage regulation</td><td>Yes</td><td>No</td></tr><tr><td>6</td><td>lumen output</td><td>Less</td><td>More</td></tr></tbody></table>	S.No.	Points of comparison	filament Lamp	Fluorescent Lamp	1	Quality of light	Good	Best	2	Capital and Running cost	Capital cost is less and Running cost is more as life is less	Capital cost is more and Running cost is less as life is more	3	Lamp efficiency	Less (12 to 15 lm/w)	More (40 to 60 lm/w)	4	Lamp Life	less	More	5	voltage regulation	Yes	No	6	lumen output	Less	More	
S.No.	Points of comparison	filament Lamp	Fluorescent Lamp																											
1	Quality of light	Good	Best																											
2	Capital and Running cost	Capital cost is less and Running cost is more as life is less	Capital cost is more and Running cost is less as life is more																											
3	Lamp efficiency	Less (12 to 15 lm/w)	More (40 to 60 lm/w)																											
4	Lamp Life	less	More																											
5	voltage regulation	Yes	No																											
6	lumen output	Less	More																											
b)	Explain general rule; general principles; design considerations and types of lamps for street lighting.																													
Ans:	General rule; general principles; design considerations and types of lamps for street lighting: General rule and design consideration: (Any four point expected: 1/2 Marks each) <ol style="list-style-type: none">1. The street lighting should be such that the object can be seen driver of any vehicle.2. The street lighting should be attractive.3. It should increase the community value.4. As per the Indian standard, the illumination level required for high traffic density should be 20:30 lux for medium traffic density it should be 8-15 lux & for low traffic density it should be minimum 4 lux.5. It should be such that a driver of any vehicle sees the object up to 30 mtr.6. Percentage of glare should be less so there are less chances of accidents, for that angle of reflector should be well maintain.7. It should be electrical & mechanical safe.8. The replacement of lighting accessories should be simple9. The maintenance & repairing should be simple future expansion should be carries out without any difficulty.10. It should be economical.11. For high traffic density, generally metal halide lamp, halogen lamps should be used. For medium traffic density sodium vapour lamp , mercury vapour lamp should be used & for low traffic density CFL, LED and fluorescent tube should be used. General Principals: <ol style="list-style-type: none">1. Specular-reflection principle of street lighting2. Diffusion principle																													



1) Specular-reflection principle

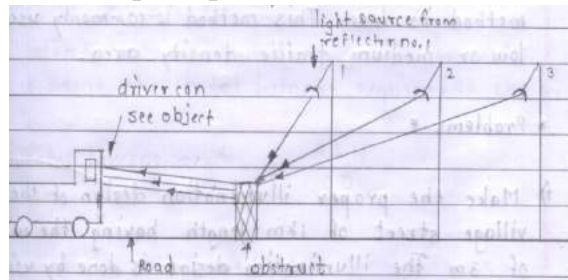

or equivalent figure

- In this method obstruction will be clearly visible to the driver by using reflectors with small angle of incidence.
- In this method reflectors are used in such a way that driver can see any object clearly from more than 40 m distance on road. So that accident will be less.
- Power consumption required for this method is less.
- This method is commonly used for low or medium traffic density area.

2) Diffusion Principle:

- In this type, the light is directed downwards from the lamps with the intention of producing a uniform illumination on the road surface.
- This is possible by use of suitably design reflectors.
- The filament of the lamp is invisible except from almost beneath it.

This illuminates glare, the road surface has a diffusing nature due to which it diffuses some proportion of light towards the observer. This makes the road surface bright for the observer.

❖ **Street lighting lamps :**

(2 Mark)

- 1) High pressure mercury vapour lamp.
- 2) High pressure Sodium vapour lamp.
- 3) Fluorescent tube
- 4) LED Lamp

Q.2	Attempt any TWO :	16 Marks
a) (i)	Explain the stepwise procedure for designing illumination scheme for residential unit.	
Ans:	Procedure for designing illumination scheme for residential unit: (Any eight point expected: 1/2 Mark each point) 1. Visit to corresponding site and make the proper survey of every room and its interior applications. Measure the dimensions of every room (length, width, height). Make the proper plan layout with proper isometric view. 2. Find out application and working plane of every room.	



	<p>3. As per the illumination standard decide proper lux level on that particular working plane.</p> <p>4. As per quality of civil work and surrounding conditions and colour of walls and ceiling decide waste light factor, utilization factor, depreciation factor etc.</p> <p>5. Find out total lumens required on working plane.</p> $\text{Total lumens required on working plane} = \frac{AIW}{CD}$ <p>6. Decide the type and wattage of lamp which is to be used for that particular application</p> <p>7. Assume the proper illumination efficiency of those specific lamps which are to be used on that working plane</p> <p>8. Find out total no. of lamps and tubes for that particular working plane and after that find out total no. of lamps & tubes or any other lamps for interior application of commercial installation. By assuming proper space to height ratio make the proper illumination scheme. This procedure is repeated for every working plane in every room.</p> <p>9. Find out total no. of lamps or tubes for that particular working plane</p> $\text{Number of Lamps required} = \frac{\text{Total Lumens Required}}{\text{Wattage of each lamp} \% \eta \text{ of each lamp}}$ <p>10. Find out total power consumption of all interior applications for calculated lamps and tubes.</p> <p>11. Find out the rated current for all applications.</p> <p>If 1Ph, 230V supply is provided, $P = VI \cos \phi$</p> <p>If 3ph, 400V supply is provided, $P = \sqrt{3} VI \cos \phi$</p> <p>12. Determine size of wire or cable required for whole residential or commercial installation. The size of wire is decided by the starting current, which is 1.5 times rated current, for momentary overload S.C. future expansion and starting surge.</p>
a) (ii)	State the four advantages of good illumination scheme.
Ans:	Following advantages of good illumination scheme: (Any four point expected-1 Mark each) <ol style="list-style-type: none">1. Good illumination scheme encourage the personnel for better working.2. In commercial, correctly planned scheme promote the sale.3. In a factory lighting arrangements are planned to increase productivity & to improve



the quality of production.

4. Correct & good illumination scheme avoid the accidents.
5. Adequate & glare free illumination provides pleasant atmosphere for staff.
6. Good lighting in schools & colleges helps in raising the average grades of the students.
7. In short good illumination scheme increases overall efficiency.
8. By proper illumination scheme energy saving will be effective & with cost saving also.
9. It should have sufficient light.
10. It should not strike the eyes.
11. It should not produce glare.
12. It should be installed at such a place that it gives uniform light.
13. It should be of correct type as needed.
14. It should have suitable sets, reflectors.

OR

1. **Comfortable:** The energy illumination scheme should be comfortable to everybody.
2. **Pleasant surrounding:** By the electrical lighting or the electrical illumination scheme the surrounding area of that location should be pleasant.
3. **Long life:** The life of the designed illumination should be large
4. **Economy:** The cost of the designed illumination scheme be low.
5. **Less Maintenance:** For only type of illumination scheme the maintenance and repairing should be less.
6. **Appearance:** The appearance of illumination scheme should be good.
7. **Less glare:** The glare is fatigue to the human eyes. The illumination scheme is designed in such away that there should be less glare to everyone i.e only electrical & mechanical accidents will be less.
8. **Less flicker:** The flicker is change in light intensity. This flicker should be always less for any type of illumination scheme. In the flicker there are changes of stroboscopic effect at the time of workshop lighting it is very imp.
9. **To avoid hard shadows:** The whole illumination scheme is designed for

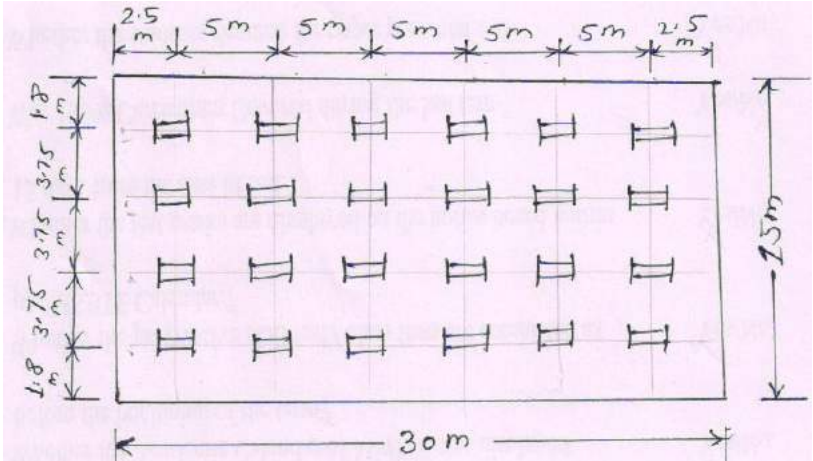

	<p>iii) Total Wattage = Total No. of Lamps x wattage of lamp = 48 x 80 = 3840 watts -----(2 Marks)</p> <p>iv) Space & Mounting height: \therefore Space = 3.75 mtr and mounting height 5 mtr</p> <p>OR</p> <p>\therefore Space = 3.75 mtr and mounting height 5 mtr</p> $\frac{3.75}{5} = 0.75$ -----(1 Marks) <p>Working plane is assumed as a ground surface</p> <p>Arrangements of Fluorescent Tube : -----(1 Marks)</p>  <p style="text-align: center;">Or equivalent layout</p>
<p>c) (i)</p> <p>Ans:</p>	<p>Explain stage lighting for Auditorium. ----- (2 Marks)</p> <p>Explanation of Stage lighting for auditorium:</p> <p>Generally Stage are required to perform various social & cultural activities. For e.g. Dance, Drama, gathering etc. The stage lighting is commonly used for to fulfill all these activities and is very important part of this program.</p> <p>Lamps used for stage lighting: ----- (2 Marks for Any one lamp)</p> <p>For the stage lighting multicolours LED lamps, Compact fluorescent lamp (CFL), small capacity projector lamps, metal halide lamp, & other types of advanced lighting system can be provided.</p>



c) (ii)	State the lamps used for Agriculture and Horticulture.
Ans:	<p>Following Lamps used agriculture and horticulture:- (4 Marks)</p> <p>If any type of agriculture or horticulture premises if the natural sunlight is not available then high pressure sodium lamps and metal halide lamps are to be used.</p> <p>The requirement of agricultural or horticultural lighting is similar of flood lighting and lighting calculations is also same. Only difference is that basic lux level is decided by the type of applications.</p> <p>In the greenhouse the fluorescent tubes, the CFL are also used for energy saving purpose. The metal halide lamps which are to be used in the green house having the wattage of 75W, 250W and 400W.</p> <p>In any types of green house, the all environmental condition which are required for plant growth these all conditions are artificially provided by the lighting scheme. These all Surrounding conditions may be room temp. Humidity, wind pressure, sunlight and percentage of water.</p> <p>In the green house we can use standard high pressure lamp of 250W, 500W, 1000W etc. In these types of lamps, there may be sodium vapour lamp and mercury vapour lamp.</p>
Q.3	Attempt any FOUR : 16 Marks
a)	Define the following terms : (i) Luminous flux (ii) Utilization factor (iii) Mean Spherical Candle Power (MSCP) (iv) Lamp efficiency
Ans:	<p>i) Luminous flux (F):- (Each Definition: 1 Mark)</p> <p>The total energy radiated by a source of light in all directions in unit is called Luminous flux. And its unit is Lumen</p> <p style="text-align: center;">OR</p> <p>Luminous flux is commonly called light output and is measured in lumens (lm).</p> <p>ii) Utilization factor:-</p> <p>It is defined as the ratio of total lumens reaching the working plane to the total lumens given out by the lamp. Its value is always less than one.</p> <p>iii) MSCP (Mean Spherical Candle power):</p> <p>It is the average of all candle powers in all direction in all planes. OR</p> $MSCP = \frac{\text{Total Luminous flux in lumens}}{4 \pi}$ <p>iv) Lamp η (lamp efficiency):-</p> <p>It is defined as the ratio of the total luminous flux emitting from the source to Its electrical power input in watts.</p>



b)	Distinguish between direct lighting and indirect lighting (any four point).	
Ans:	(Any Four point expected : 1 Mark each)	
	S.No	Direct lighting
	1	
		Indirect lighting
	2	It is not commonly used type of lighting scheme.
	3	In this type more than 90% of total light is directed towards working plane.
	4	It is more efficient
	5	It cause glare & hard shadows
	6	It gives tunneling effect i.e ceiling of room remains OFF
	7	It is used for industry, domestic and general outdoor lighting
	8	Power consumption for direct lighting scheme is less
	9	Efficiency for direct lighting scheme is high
	10	The percentage of glare is more
	11	The percentage of shadows are more
	12	E.g. Flood lighting, Play ground lighting, lighting in drawing hall etc
	2	In this the light does not reach the Working plane directly from the lamp
	3	The light is directed towards ceiling & walls from where it is indirectly reaches the W.P.
	4	It is also called diffused reflection
	5	It provides shadow less illumination
	6	No Glare
	7	It is used for drawing offices, composing rooms, hotels and workshop
	8	Power consumption for indirect lighting scheme is More
	9	Efficiency for indirect lighting scheme is less
	10	The percentage of glare is Less.
	11	The percentage of shadows are less
	12	E.g. Restaurants and Hotels, Conference room, Guest room etc.
c)	Explain TRIAC operated dimmer for light control.	
Ans:	TRIAC operated dimmer for light control – (Figure: 2 Mark & Explanation: 2 Mark)	
	OR	
	or equivalent figure	



	<p>In this method, the limitation of thyristor operated dimmer is overcome. The triac is nothing but two SCR connected back to back and gate terminal is common. It will conduct +ve or –ve half cycles.</p> <p>Whenever capacitor C1 & C2 are charged through the resistance R1 & R2 for +ve half cycle, capacitor C2 will be discharged through the gate terminal i.e. why the firing angle or conduction angle is decided by this R2C2 values.</p> <p>But for the –ve half cycles the capacitor C1 is charged & discharged through the R1 & firing angle is decided by this R1C1 values.</p> <p>In this way both half cycles are controlled by using triac type dimmer. To get the unidirectional pulse diac is used in series with the gate.</p> <p>This method is commonly used for light intensity control and other application also e.g. fan regulator.</p>
<p>d)</p>	<p>State the requirements of illumination scheme for a shipyard.</p>
<p>Ans:</p>	<p>Following requirements of illumination scheme for a shipyard:</p> <p style="text-align: center;">(Any Four requirement are expected: 1 Mark each)</p> <ol style="list-style-type: none">1. The shipyard lighting always depends upon the all surrounding conditions for e.g. wind pressure, rain fall, location of shipyard from the sea-shore etc.2. The shipyard lighting always depends upon the type & capacity of alternator which is held in ship for interior applications and the capacity of alternator which is installed in the ship-yard and any other non-conventional sources installed in that particulars area for all outdoor application.3. In the every shipyard there may be limitation conventional sources to over-come these limitations sometimes non-conventional sources for e.g. solar, tidal, wave-let, etc non-conventional energy sources are to be used. At the time of illumination design we have to consider this factor.4. In the ship-yard after scotching various shipyard is necessary for this case control room, emergency –control, emergency medical centre. Loading and loading areas etc. are required, at the time of illumination design we have to consider all these applications for its standard lux level.5. In the every ship-yard the electrical & mechanical safety is the prime-moto. At the time of illumination design the all safety precautions are to be taken.6. The life of the shipyard lighting should be always more.7. The cost of the ship-yard lighting should be always economical.8. The every ship-yard station should be free from any type of pollution for e.g. water pollution, sound pollution or noise pollution to the commercial communication



	<p>signals.</p> <p>9. At the time of ship-yard lighting for the outdoor applications we have consider total area of water, which is covered by the illumination.</p> <p>10. The ship-yard lighting is always at the remote place slightly away from the sea-share, so at the time of ship-yard lighting the every wiring & can be replace easily.</p> <p>11. The maintenance and the repairing of the shipyard lighting system should be simple & less, at the time of ship-yard lighting the navigation signals and lights are very important to control the various ships at the time of ship-yard lighting we have to consider this factor also.</p> <p>12. In the ship-yard lighting the various lamp are used to get the proper lux level and for energy saving purpose also, the some of the lamps are as below-forge, Bollards, foot lamps, solar grass lamps, LED-Solar energy lawn lamps, various focus lamps, metal halide lamps etc.</p>
e)	State the different types of outdoor flood lighting and where are they used?
Ans:	Flood light type depend on following : (4 Mark) There are three types of projector : a) Narrow beam Projector b) Medium angle Projector c) Wide angle Projector a) Narrow beam Projectors: - Light beam with such a projectors spreads between 12° and 25° . They can be employed for a distance of 70 meter. b) Medium angle Projectors: - Projectors with beam spread between 25° and 40° . These are employed for a distance of 30-70 meter. c) Wide angle Projectors: - A projector with beam spreads between 40° and 90° . They can be employed for a distance of 30 meter or below. OR 1) It is used for buildings at night, ancient building and monuments, churches & gardens etc 2) It is used for illuminating railway yards, stadiums, car parking area etc. 3) It is used for illuminating advertisements, boarding's etc

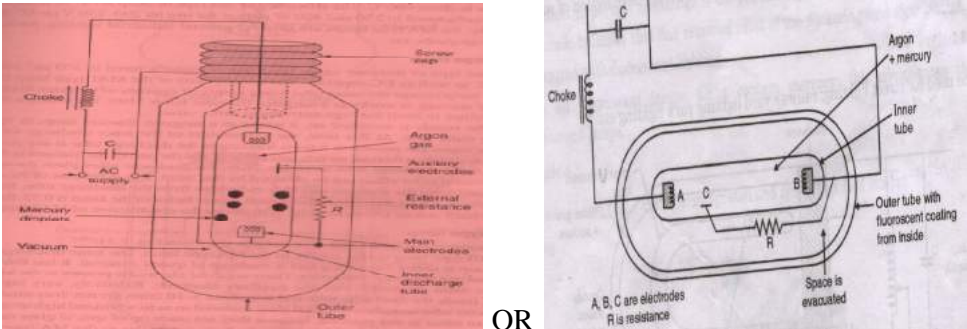

Q.4 A)	Attempt any THREE :	12 Marks
a)	Draw and explain construction of mercury vapour lamp.	
Ans:	Diagram of mercury vapour lamp: (Figure: 2 Mark, Construction: 2 Mark)	
		
OR		
or equivalent figure		
Construction:-		
<ul style="list-style-type: none">➤ MV lamps consist of an arc tube (inner) enclosed by an outer tube.➤ Vacuum is created between the inner & outer glass tube to prevent heat loss/ the space between the two is filled with nitrogen.➤ The inner bulb contains neon or argon gas with certain quantity of mercury.➤ Arc tube also contains two electrodes and starting electrode.➤ It requires a ballast to give high voltage at starting to produce the arc.➤ The capacitor is used to improve the power factor.		
OR Student may write		
Construction:-		
<ul style="list-style-type: none">➤ It consists of an inner bulb generally of silicon, to withstand high temperatures.➤ The bulb contains a small quantity of mercury and argon.➤ It is protected by outer glass, this may be cylindrical or elliptical.➤ The space between the two bulbs is filled with nitrogen at a pressure of half atmosphere.➤ The discharge tube has three electrodes, namely two main electrodes A and B and one starting electrode.➤ The starting electrodes are connected through a resistance of about 10-30 k ohm to the main electrode, located at the far end.➤ The electrodes are of tungsten wire helices filled with electron emissive materials, usually barium and strontium carbonates mixed with thorium.		
OR Student may write		
<p>The construction & connection diagram is as shown in figure. As per this construction there are following components.</p>		



- **Choke:** The choke is acting as the ballast. At the time of supply voltage variation of current flowing through the inner tube is maintained constant to keep uniform light intensity. Sometimes choke can be designed for to get the higher voltages & to apply the inner tube of mercury vapour lamp.
- **Starting resistance/limiting resistance:** Whenever current flows through the starting resistance there is a I^2R loss which is converted into heat. If the temperature of this heat goes near about 6000°C then there will be heating effect & inert gases ionization will be start.
- **Auxiliary electrode & Main electrode:** It is made by high resistive element. The ionization is taking place through the inert gases whenever current flows from auxiliary electrode to main electrode.
- **Inner Tube:** The various inert gases e.g. Argon, Nitrogen etc with mercury powder are filled in the inner tube at low pressure or high pressure.
- **Outer Tube:** The function of outer tube is to make the vacuum surrounding the inner tube to avoid thermal dissipation or to maintain 6000°C surrounding the inner tube.
- **Power factor improvement Capacitor:** The function of power factor improvement capacitor is to improve the power factor 0.5 to 0.95

b) Explain meaning and applications of polar curves for designing the lamps.

Ans: **Meaning of Polar Curves:-** (Meaning : 2 Marks & Application : 2 Marks)

Polar curves are graphical representation of light intensity with respect to angular position in horizontal or vertical plane passing through the light source.

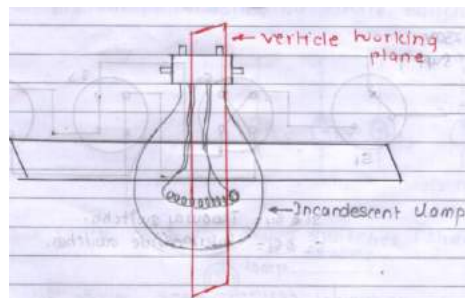

or equivalent figure

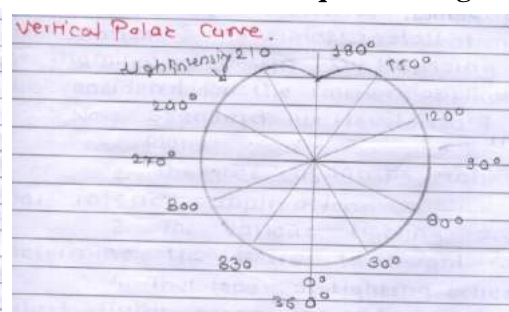
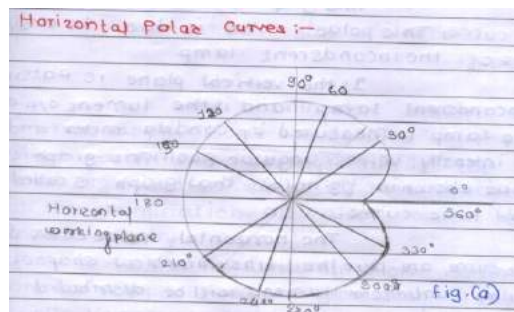



	<p>Importance of polar curves in illumination Engg:-</p> <p>The polar curves are required to determine the mean horizontal candle power (MHCP) and mean hemispherical candle power (MHSCP). The polar curves are due to limitations of unsymmetrical design shape of the incandescent lamp. The polar curves are required for illumination design</p> <p><u>Applications of polar curve:</u></p> <ol style="list-style-type: none">1. To decide the MHCP and MHSCP2. For proper illumination design3. It indicates coverage of lights which helps lighting scheme.4. To know the intensity of light emitted by the source in different direction.
c)	<p>State general requirements of factory lighting.</p>
Ans:	<p>The following general requirement of factory lighting:-</p> <p>(Any eight point expected– 1/2 Marks each)</p> <ol style="list-style-type: none">1. The operation of factory lighting and its control should be simple.2. At the time of factory lighting, the surrounding conditions inside the factory should be pleasant to every worker & officer to increase their work efficiency.3. The all safety precautions are to be consider at the time of factory lighting to avoid the chances of electrical & mechanical accidents and danger of fire hazard.4. The maintenance, repairing and expansion in the factory lighting should be less and simple.5. The replacement of any lighting device or accessories should be so simple.6. The cost of factory lighting for indoor and outdoor applications should be less.7. The indoor and outdoor applications the life of the factory lighting should be high.8. The percentage of glare in the factory lighting should be less.9. The stroboscopic effect and Shadows due to the lighting in the workshop should be very less.10. The overall power consumption of indoor and outdoor applications of factory lighting should be less. In that case energy saving lamp are to be used.11. Sometimes, Direct lighting scheme or indirect lighting scheme is also used for the factory lighting12. For the particular factory, I there is showroom, in that case the various colour effects by using the focus lamps are used.13. For factory lighting for indoor applications, we can use fluorescent tube, incandescent lamp, CFL and LED etc, but for outdoor applications we can used focus lamp of halogen or metal halide lamps.14. For the factory lighting, for the indoor applications the illuminations design procedure is regular but depreciation factor, waste factor are changed.15. Sometimes for the factory lighting the factory building surface is to be illuminated



by flood lights.

OR

- 1) The type of industry or factory.
- 2) The total premises area of the whole factory in m^2 .
- 3) The location of the factory.
- 4) The surrounding conditions. e.g. wind pressure, natural sun light, rainfall, etc.
- 5) The type of product which are manufactured in the factory.
- 6) The total indoor & outdoor area of the given factory.
- 7) The necessary lux level for the outdoor locations to increase the beauty of the factory at night, and pleasant working conditions.
- 8) The working plane required for the indoor application whether it is a ground surface or above ground surface.
- 9) The application of every room in the given factory. e.g. office, workshop, Research & development centre, testing centre, maintenance & repairing department, quality control department, sales department, commissioning department, showroom, guest room etc.
- 10) The required lux level for indoor premises in the given factory is decided as per application of department. e.g. In Workshop - 200 lux, e.g. In Showroom - 350 lux Above lux level is assumed.
- 11) As per civil construction work, the colour of ceiling walls & machines. The waste Light factor, utilization factor & depreciation factor is decided.
- 12) To minimize the stroboscopic effect & to minimize the glare the combination of various types of lighting source are selected.
- 13) The location & mounting of light source are selected in such a way that electrical & mechanical accident will be less.
- 14) The maintenance and repairing work for the whole illumination scheme should be less.
- 15) The overall cost of the illumination scheme should be less.
- 16) The lighting sources are selected in such a way that the overall power consumption will be less.
- 17) The lighting sources are selected and the illumination scheme is designed in such a way that the replacement of lighting accessories will be simple.
- 18) If expansion is required then it should be possible in present illumination scheme.



d)	Explain design considerations for sports ground lighting.
Ans:	Design considerations for Sports Ground lighting: (Any Four point expected– 1 Marks each) <ol style="list-style-type: none">1) Types of sports –indoor or outdoor.2) Illumination level required for that sport.3) Time of sports whether it is day or night.4) Area of illumination which is to be illuminated.5) Surrounding conditions of the ground.6) Height of the tower for the flood light which is installed near to or surrounding the ground.7) At the time of sports light regular designing factor for example, working plane area, utilization factor waste light factor depreciation factor etc. are to be considered.8) Power required and available should be also taken into account.9) Maintenance and repairing cost should be also less.10) Life of the projector & bunched filament lamp should be high.
Q. 4 B)	Attempt any ONE : 06 Marks
a)	State and explain any six factors while considering the designing the illumination for interior location of commercial.
Ans:	Following factors while considering the designing the illumination for interior location of commercial. (Any six point expected: 1 Mark each) <ol style="list-style-type: none">1. Comfortable: The energy illumination scheme should be comfortable to everybody.2. Pleasant surrounding: By the electrical lighting or the electrical illumination scheme the surrounding area of that location should be pleasant.3. Long life: The life of the designed illumination should be large4. Economy: The cost of the designed illumination scheme be low.5. Less Maintenance: For only type of illumination scheme the maintenance and repairing should be less.6. Appearance: The appearance of illumination scheme should be good.7. Less glare: The glare is fatigue to the human eyes. The illumination scheme is designed in such away that there should be less glare to everyone i.e only electrical



& mechanical accidents will be less.

8. **Less flicker:** The flicker is change in light intensity. This flicker should be always less for any type of illumination scheme. In the flicker there are changes of stroboscopic effect at the time of workshop lighting it is very imp.
9. **To avoid hard shadows:** The whole illumination scheme is designed for minimum shadows. At the time of flood light the hard shadows are avoided.
10. **Sufficient lux level:** The lux level is decided by the type of applications, type of location & their countries standard
11. **Cleanliness:** The illumination scheme should be free from any type of ash, smoke or any other air pollution it should be clean.
12. **Simple control:** The illumination scheme designed by the electrical lighting is very simple. The control, multicolor light intensity control is also possible in electrical illumination.

OR

- 1) **Level of illumination or degree of illumination:** It depends on nature of work to be carry out. The degree of level of illumination also depends on following factors.
 - i) The size of object & its distance from observer.
 - ii) If object is moving higher level of illumination is required than stationary object.
 - iii) If the objects are required to be seen for long duration of time, higher level of illumination is necessary & for stair cases, corridors less illumination is required.
- 2) **Glare:** The glare causes unnecessary eye fatigue so it must be avoided, it can be prevented by using diffusing glass screen, suitable reflectors & proper mounting height. Reflected glare from the polished surfaces within the line of vision should be avoided.
- 3) **Shadows:** The formation of long and hard shadows must be avoided. The long and hard shadows cause accident. Such shadows can be avoided by
 - i) Using proper mounting height of the lamps. ii) Using more number of lamps & providing indirect lighting. iii) Employing wide surface sources of light.Complete absence of shadows is again not recommended as soft shadows are required to identify three dimensional objects.
- 4) **color rendering:** This refers to the ability of the light source to reproduce the original colour of the objects when the object is illuminated by that source.
- 5) **Lamp fittings:** The lamp fittings serve the following functions in good illumination scheme.
 - i) To diffuse the light ii) To cut off the light at certain angle to avoid glare iii) To



give mechanical protection to light source. iv) To increase the aesthetical requirement of the premises. V) To control the level of light (control gear)

6) Maintenance: Regular cleaning of lamps & light fittings is necessary to maintain their efficiency. The maintenance is necessary against dust, water leakage, dangerous gases which may cause corrosion of light fittings. Hence light fittings should be simple & easy from maintenance point of view.

7) Following factors are considered while designing interior illumination: utilization factor, depreciation factor, Maintenance factor and space to height ratio.

OR

The stepwise factors while designing the illumination for interior location of commercial: (Any Six factor expected 1- Mark each)

1. Visit to corresponding site and make the proper survey of every room and its interior applications. Measure the dimensions of every room (length, width, height). Make the proper plan layout with proper isometric view.
2. Find out application and working plane of every room.
3. As per the illumination standard decide proper lux level on that particular working plane.
4. As per quality of civil work and surrounding conditions and colour of walls and ceiling decide waste light factor, utilization factor, depreciation factor etc.
5. Find out total lumens required on working plane.

$$\text{Total lumens required on working plane} = \frac{AIW}{CD}$$

6. Decide the type and wattage of lamp which is to be used for that particular application
7. Assume the proper illumination efficiency of those specific lamps which are to be used on that working plane

13. Find out total no. of lamps and tubes for that particular working plane and after that find out total no. of lamps & tubes or any other lamps for interior application of commercial installation. By assuming proper space to height ratio make the proper illumination scheme. This procedure is repeated for every working plane in every room.

14. Find out total no. of lamps or tubes for that particular working plane

$$\text{Number of Lamps required} = \frac{\text{Total Lumens Required}}{\text{Wattage of each lamp} \% \eta \text{ of each lamp}}$$

15. Find out total power consumption of all interior applications for calculated lamps and tubes.



	<p>16. Find out the rated current for all applications.</p> <p>If 1Ph, 230V supply is provided, $P = VI \cos \phi$</p> <p>If 3ph, 400V supply is provided, $P = \sqrt{3} VI \cos \phi$</p> <p>Determine size of wire or cable required for whole residential or commercial installation.</p> <p>The size of wire is decided by the starting current, which is 1.5 times rated current, for momentary overload S.C. future expansion and starting surge</p>
b) i)	Explain the following related to illumination control :
(i) Control of enhancing lighting	
Ans:	Control of enhancing lighting: (3 Marks) <ul style="list-style-type: none">➤ Enhancing lighting is commonly used for decoration and Effective of visualization of gold, silver, diamond, watches showroom purpose.➤ Various colour effect and light intensity is controlled in enhancing lighting.➤ When lighting controls are used properly energy will be saved & life of the lamps & accessories can be extended.➤ Lighting control will help to reduce energy bill by:<ol style="list-style-type: none">1. reducing the amount of power used during peak demand period by automatically dimming the lights & turning them off when they are not needed.2. Reducing the number of working hours of lighting source.
b) ii)	(ii) ON/OFF control & Dimming control
	➤ ON/OFF control technique : (1.5 Mark) <p>A most common type of lighting control is ON/OFF toggle switch other types of lighting control include occupancy sensors, day light sensors, a variety of manual & automatic dimming devices and centralized controls.</p> <p>Occupancy sensors including passive infrared, ultrasonic and dual technology sensors served three basic functions.</p> <ol style="list-style-type: none">i) To turn automatically light ON when a room becomes occupied.ii) To keep the light ON without interruption whiles the controlled space is occupied.iii) To turn the lights OFF within a preset time period after the space has been vacant.iv) Lux method for light intensity control can be used.v) One and Two way switch used for controlling from two different places.



	<p>➤ Dimming Control: (1.5 Mark)</p> <p>i) Light intensity of lighting source is controlled smoothly. ii) Simple to control and handle. iii) Light in weight iv) Compact in size as compare to electric dimmer v) Light intensity can be controlled by controlling voltage, current and frequency. vi) Due to simple in operation can be used for stage lighting, garden lighting etc.</p>																								
Q.5	Attempt any TWO 16 Marks																								
a)	<p>(i) State the recommended illumination level required for any four areas of hospital lighting. (ii) List the various indoor lighting schemes and explain any one of them with sketch.</p>																								
Ans:	<p>(i) Recommended illumination level required for any four areas of hospital lighting: (Any Four areas required- 1 Mark each)</p> <table border="1"><thead><tr><th>S.No</th><th>Areas</th><th>Recommended illumination level</th></tr></thead><tbody><tr><td>1</td><td>Reception & Nursing</td><td>250 to 300 lux station</td></tr><tr><td>2</td><td>Corridors & circulation</td><td>40 to 60 lux areas</td></tr><tr><td>3</td><td>Patient wards -</td><td>100 to 200 lux</td></tr><tr><td>4</td><td>Operation theatres -</td><td>600 to 1000 lux</td></tr><tr><td>5</td><td>ICU -</td><td>500 to 700 lux</td></tr><tr><td>6</td><td>General ward</td><td>100 to 200 lux</td></tr><tr><td>7</td><td>Special ward</td><td>150 to 250 lux etc</td></tr></tbody></table> <p>(ii) List the various indoor lighting schemes and explain any one of them with sketch. (ii) List the various indoor lighting: (Any Two Schemes expected: 1/2 Mark each)</p> <ol style="list-style-type: none">1. Direct Lighting Scheme2. Indirect lighting scheme3. Semi direct Lighting Scheme4. Semi indirect lighting Scheme5. General Lighting Scheme <p>Explanation : (Any one explanation Expected: Figure; 1 Mark & Explanation: 2 Mark)</p>	S.No	Areas	Recommended illumination level	1	Reception & Nursing	250 to 300 lux station	2	Corridors & circulation	40 to 60 lux areas	3	Patient wards -	100 to 200 lux	4	Operation theatres -	600 to 1000 lux	5	ICU -	500 to 700 lux	6	General ward	100 to 200 lux	7	Special ward	150 to 250 lux etc
S.No	Areas	Recommended illumination level																							
1	Reception & Nursing	250 to 300 lux station																							
2	Corridors & circulation	40 to 60 lux areas																							
3	Patient wards -	100 to 200 lux																							
4	Operation theatres -	600 to 1000 lux																							
5	ICU -	500 to 700 lux																							
6	General ward	100 to 200 lux																							
7	Special ward	150 to 250 lux etc																							



i) Direct lighting :

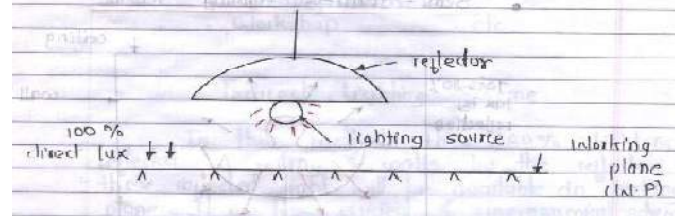

In this method, the reflector is used on the lighting source. The 100% light is reflected by this reflector on the working plane. So efficiency of direct lighting scheme is very high and it is economical also. But limitation of direct lighting scheme is that glare & shadows are more. The direct lighting scheme is widely used in drawing room, workshop etc.

Drawbacks of direct lighting system: (Any one point expected)

1. This scheme is more efficient but it suffers from hard shadows and glare.
2. These light creates tunneling effect i.e ceiling remains dark.

ii) Indirect lighting scheme :-

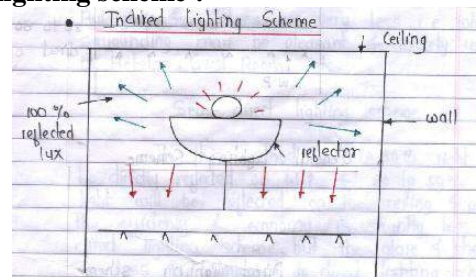

or equivalent figure

In this method the 100% light is reflected on ceiling and walls by the reflector and this reflected light will be available on working plane. It is less efficient and uneconomical scheme but glare and shadows are very less. i.e. why surrounding may be pleasant and widely used in hotels, guest room etc.

iii) Semi direct lighting scheme :-

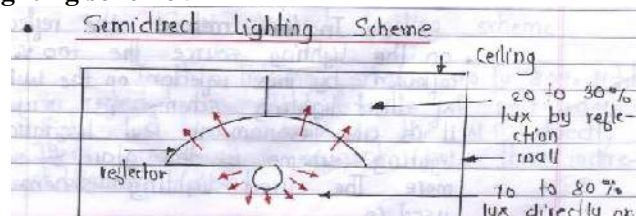

In this method, the 70 to 80% light will be directly reflected on the working plane



and 20 to 30 % light will be reflected on the ceiling and walls. The efficiency and economy is slightly less than direct lighting scheme. But the glare and shadows are less as compare to direct lighting scheme.

iv) Semi indirect lighting scheme :-

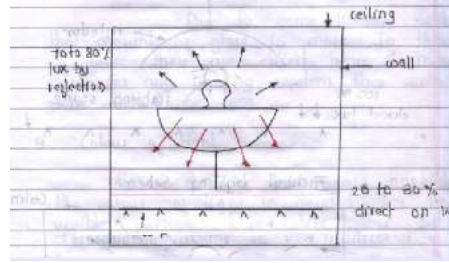

or equivalent figure

In this lighting scheme, 70 to 80% light is reflected on ceiling & walls and 20 to 30% light will be available on the working plane directly. It is economical and efficiency as compared to indirect lighting scheme.

v) General lighting scheme:-

In this lighting scheme, the reflector is not used on the light source, so the lumens emitted by the light source will be reflected on ceiling wall and can be available directly on working plane also.

This method is commonly used in various residential, commercial and industrial installations.

- b) (i) Explain lighting for advertisement.
(ii) Explain different types of reflectors which are used for enhancing interior illumination.**

Explanation of lighting for advertisement:

(4 Marks)

- Advertisement or hoarding may be on the following: uni-poles, uni-structure, hoarding (ground level or roof top), Electric poles, public or private building, Trees and Foot over bridges etc.
- Lighting for advertisement should not contain red, blue, green, yellow, Amber (Dark yellow) coloured light sources as these are used in traffic signals, railway signal or in emergency services etc.
- Flood lighting used for advertisement light should not face the observer directly.
- Advertisement illuminated with very high intensity of light so as to cause glare or damage of vision of the drivers or pedestrians should not be allowed.
- Advertisement illuminate in such way as to reduce effectiveness of any official sign or signals shall not be allowed.

OR



Lamps used for advertisement lighting:-

(Any Two Lamps expected each Lamp 2 Mark)

i) Neon tubes:-

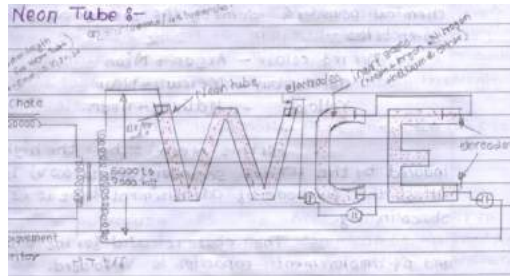

or equivalent

The construction & circuit diagram for neon tube is as shown in fig. Basically neon tube is used for advertisement or decoration purpose. The maximum length of tube is 8m. The available diameter for neon tubes are 5mm, 10mm, 15mm, 20mm, 30mm, etc.

In the neon tube we can achieve various colours with addition of the chemical powders & some of the inter gases. For this neon tube the high voltage induced by H.T. transformer secondary (5000 to 7000V) is applied across the electrodes of advertisement tube.

- The choke is used for ballast & power factor improvement capacitor is also used. For the neon tube the continuous high voltage is required, so that following precautions should be taken.
- The neon tube should be installed by government authorized supervisor.
- The metal body of the HT transformer must be earthed separately.
- Caution notice of danger board is required.

ii) Metal Halide lamp:

Constructional it is similar to mercury lamp. Its discharge tube (inter tube) contains a drop of mercury which is named as 'metal' and halides such as thallium, indium or sodium, So the lamp is named as metal halide lamp.

Its operation is some similar to the mercury lamp. An arc is established between one main electrode & auxiliary electrode through argon gas and then regular discharge takes place between two main electrodes through mercury vapour. The light is produced from an excited mercury vapour and the products of dissociation of halide.

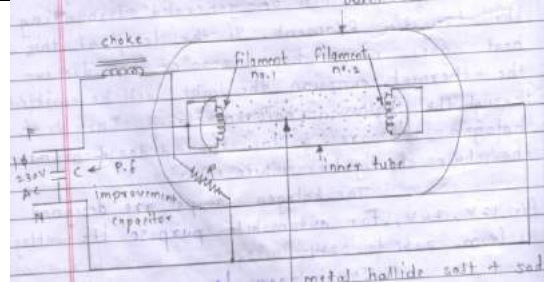

or equivalent figure

The halide cycle in metal halide lamp.

- Metal (mercury) atoms move from electric arc towards the tube wall where the halides are present.
- Near the wall, the temperature & vapors pressure allows the metals & halides to form a stable molecule which is known as metal halide molecules.
- When metal halides approaches the arc, molecules break apart.
- The halide move towards the wall and metals are excited and give out energy in the form of light.
- When enough metal atoms or loss during the operation the lamp fails.
- The outer glass may or may not be phosphor coated from inside.
- Electronic or auto transformer type ballast is used initiate the arc and to control the current,
- The capacitor is used to improve the power factor.
- The power ratings of lamp are from 175 watts to 1000 watts.
- The life is 2000 working hours.
- Some metal halides are used in indoor applications and the compact metal halide lamps are used for display and flood light etc.

iii) Halogen Lamp:-

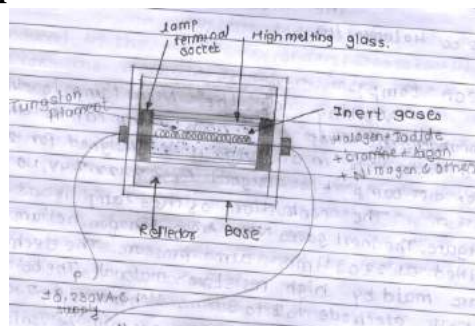

or equivalent figure

- This is one type of incandescent lamp having number of advantages over the ordinary incandescent lamp.
- The life & efficiency of an incandescent lamp is affected by the gradual & evaporation of tungsten and also its operating temperature but the addition of small amount of halogen vapour to the gas in bulb restores.



- The evaporated tungsten vapour back to the filament by means of chemical reaction and the cycle goes on.
- Halogens are a group consisting of the elements chlorine, fluorine & bromine & iodine. As a result halogen lamps have the following advantages.
- There is no blacking of bulb so there is no depression of light output.
- It has 50 % more efficiency than that of an ordinary incandescent lamp.
- It is smaller in size.
- It gives better coloured radiation.
- Halogen lamp are manufacture upto 5KW and are suitable for outdoor illuminations such as illumination of building, airports, parking.

iv) LED Lamp:-

The working principle of LED is similar to diode (P-N junction) whenever DC current flows through the light emitting diode, if the current path is from anode to cathode there will be voltage drop across the diode. It is 1.5V to 2.1V then light will be emitted through this diode.

- The LED lamps are energy saving lamps,
- The power consumption of the single LED is very less. It is in mw. So by using series & parallel combination of LED.
- The LED lamp is manufactured the available wattage for the LED lamps are 1W,2W 3W, 5W etc.
- The LED lamps is available in various colours and diameter. The life of LED lamp is very high minimum 10000 working hours.

ii) Explain different types of reflectors are used for enhancing interior illumination :

(Any Two Types expected each type- figure 1 Mark & Explanation: 1 each type)

i) Diffusing Fitting:-

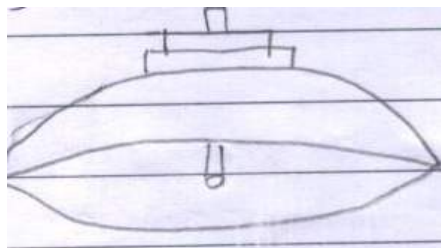

or equivalent figure

These give high quality of light minimizes glare and gives less shadows. A diffusing glass screen may be fixed across the standard reflector in order to get more diffused light.

ii) Concentrating Fitting:-

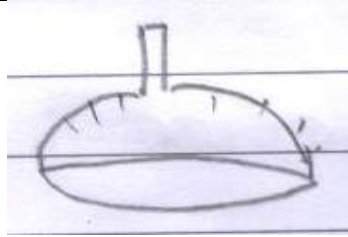

or equivalent figure

These have a shape of deep parabola. Space to height ratio required is to get uniform distribution of light waste light factor is more in such cases. It is suitable for high mounting height as required in workshop and industries, having electric overhead cranes.

iii) Dispersive Reflector:-

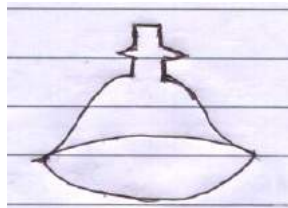

or equivalent figure

This is most commonly used in industries. The space to height ratio is 1.5, which gives uniform from illumination. These are preferred for moderate ceiling height.

The lamps rated for 40-1500 watt are fixed inside for reflector.

iv) Angle Reflectors:-

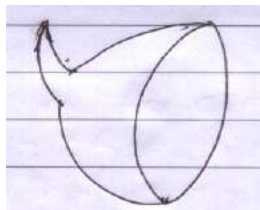

or equivalent figure

The vertical surface cannot be illuminated by normal overhead lamps, in such cases angle reflectors are used. These are available in various shapes like parabolic, elliptical etc. The choice depends on the requirement illumination.

- c) (i) Explain electric dimmer transformer and their types used for illumination control.
(ii) List the different medical lamps used in various sections of hospitals.

Ans: (i) Types of Electric Dimmer Transformer used for illumination control:

(Any two types- 2 Mark & explanation 2 Mark)



- 1) Dimmer by using changing resistance (Rheostatic)
- 2) By using auto transformer
- 3) By salt water method
- 4) By two winding transformer tap changing method

1) Dimmer by using changing resistance – (Explanation not required)

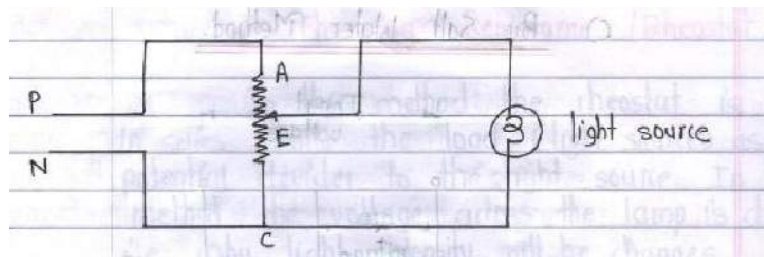

or equivalent figure

- In this method as resistance changes output voltage across the light sources changes of that light intensity will be changes.

2) By using auto transformer –

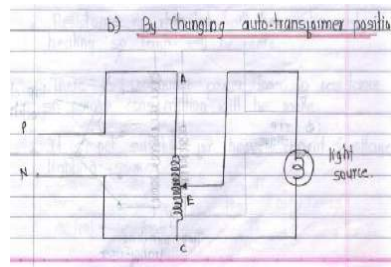

or equivalent figure

- As position of dimmer or auto transformer changes output voltages across light source will changes .So that light intensity also changes.

3) By salt Water method –

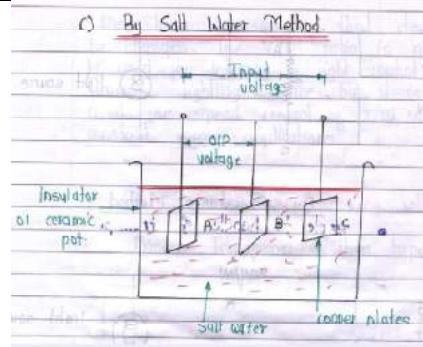

or equivalent figure

- As position of rod in immersed position changes output voltage across light sources will be changes .So that light intensity also will be changes.

4) By two winding transformer tap changing method –

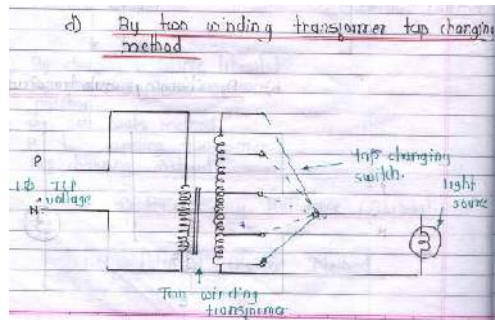

or equivalent figure

- Output voltage across the source depends upon tap position of the two winding. Transformer so that light intensity of light sources will be changes.

(ii) Following List the medical lamps used in various sections of hospitals.

(Any four sections expected-1 Mark each)

- Waiting room-**fluorescent tube, CFL, incandescent lamp, etc.
- Consulting room-** fluorescent tube, CFL, incandescent lamp, torch, etc. Diagnostic Lamp
- Operation theatre-** Ultra violet lamp, Halogen lamp, small capacity metal halide lamp, bunched filament lamp
- Medical Store room-** fluorescent tube, CFL, incandescent lamp, etc
- General & special ward -** fluorescent tube, CFL, incandescent lamp, Infrared lamp etc

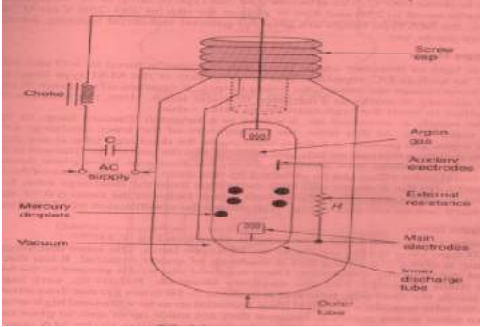
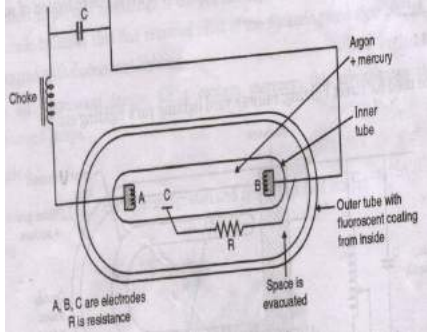

	f) ICU- Halogen lamp, small capacity metal halide lamp, bunched filament lamp etc.
Q.6	Attempt any FOUR : 16 Marks
a)	Explain construction and operation of lamp used for railway platform lighting.
Ans:	lamp used for railway platform lighting: (Figure: 2 Mark & Explanation: 2 Mark) <ol style="list-style-type: none">1. Metal halide lamp2. LED3. Sodium vapour lamp4. Mercury vapour lamp5. CFL6. Fluorescent tube (Explanation of construction and operation of following any one lamp expected: 4 Mark) 1) Mercury vapour lamp: (Figure: 2 Mark, Construction: 2 Mark)   Construction; <ul style="list-style-type: none">➤ The construction of mercury vapour lamp is as shown in figure. The mercury vapour lamps are classified into three categories: i) MA type mercury vapour lamp (low pressure) ii) MB Type MVL (HPMVL) iii) Mercury iodide➤ MA Type MVL: The constructions same as above the inert gases are filled at low pressure (2 to 3 times of atmospheric pressure). The size of this lamp is large. The illumination efficiency is 30 to 40 lumens/W.➤ MB type MVL: The construction is similar but inert gases are filled at high pressure (5 to 2 times of atmospheric pressure). The illumination efficiency is 40 to 50 lumens/watt.➤ Mercury iodide vapour lamp: It is similar to MB type MVL. Only difference is that the iodide powder is added with mercury powder. Due to this iodide is near about 78-90 lumens per watt.➤ The construction of MVL is as given in the figure.



- The power factor improvement capacitor is used to improve the P.F. from 0.5 to 0.95. The chock is inserted in series with the electrode No.1 (filament No.1)
- The starting resistance which is connected across to filament No.1 & it is connected to the neutral also.
- The vaccum is created in between the outer tube & inner tube to maintain the 6000C temperature surrounding the inner tube.
- The mercury powder is added with inert gases (Argon + nitrogen+ neon etc) in the tube or discharge tube.

OR Student May write this way

Construction:-

- It consists of an inner bulb generally of silicon, to withstand high temperatures.
- The bulb contains a small quantity of mercury and argon.
- It is protected by outer glass; this may be cylindrical or elliptical.
- The space between the two bulbs is filled with nitrogen at a pressure of half atmosphere.
- The discharge tube has three electrodes, namely two main electrodes A and B and one starting electrode.
- The starting electrodes are connected through a resistance of about 10-30 k ohm to the main electrode, located at the far end.
- The electrodes are of tungsten wire helices filled with electron emissive materials, usually barium and strontium carbonates mixed with thorium.

Working:-

- Whenever 1-ph, 230V, AC Supply is provided to the discharge tube of MVL initially to current will flow from Phase to the chock to the starting electrode to neutral.
- Sometimes the starting electrode or resistance is made by tungsten filament having the more resistance (5 to 10 K ohm) so that whenever current flows through the tungsten filament as per the thermal emission the light is emitted through the filament (tungsten immediately) so that initially colour of light is blue.
- At the same time the rated voltages is applied in between the filament No.1 & filament No.2. Due to this voltage, there will be collision. Of neon gas particles & current will start flow through the discharge tube,
- Whenever temperature surrounding the inner tube increases up to 6000C the mercury powder will start vaporizing & the continuous collision process of all inert gases is taking place so that full light is emitted through the discharge tube.
- The colour of light is bluish white. The full light is emitted after 10-15 min.



2. Sodium vapour lamp:

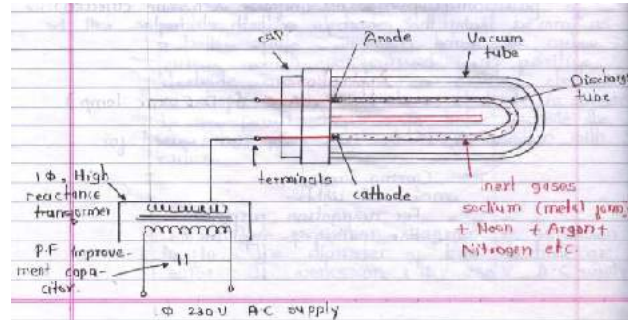

or equivalent figure

Construction:-

Above figure shows constructional details of sodium vapour lamp. It consists of 'U' shaped tube and at the ends of the tube two electrodes are sealed. This tube is filled with sodium and small quantity of neon gas. Since there is great effect of the change of surrounding temperature on the light output given by the lamp, hence the inner tube is enclosed in an outer double walled glass tube. Before sealing the lamp vacuum is created between the two glass tube (inner & outer).

Working:-

Before the lamp starts working, the sodium is usually in the solid form deposited on the sides of the inner tube wall. When the voltage is applied to the lamp it warms up and starts vaporizing slowly and radiates out yellow colour light and after about 20 minutes, the lamp starts giving its full output.

3) Metal Halide lamp:

Constructional it is similar to mercury lamp. Its discharge tube (inter tube) contains a drop of mercury which is named as 'metal' and halides such as thallium, indium or sodium, So the lamp is named as metal halide lamp.

Its operation is some similar to the mercury lamp. An arc is established between one main electrode & auxiliary electrode through argon gas and then regular discharge takes place between two main electrodes through mercury vapour. The light is produced from an excited mercury vapour and the products of dissociation of halide.

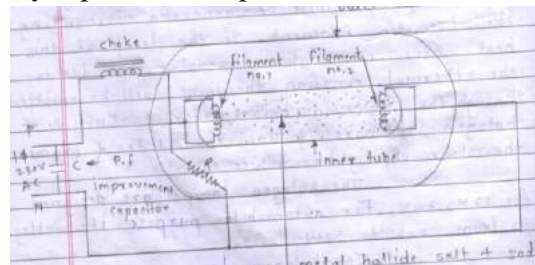

or equivalent figure

The halide cycle in metal halide lamp.

- Metal (mercury) atoms move from electric arc towards the tube wall where the halides



are present.

- Near the wall, the temperature & vapors pressure allows the metals & halides to form a stable molecule which is known as metal halide molecules.
- When metal halides approaches the arc, molecules break apart.
- The halide move towards the wall and metals are excited and give out energy in the form of light.
- When enough metal atoms or loss during the operation the lamp fails.
- The outer glass may or may not be phosphor coated from inside.
- Electronic or auto transformer type ballast is used initiate the arc and to control the current,
- The capacitor is used to improve the power factor.
- The power ratings of lamp are from 175 watts to 1000 watts.
- The life is 2000 working hours.
- Some metal halides are used in indoor applications and the compact metal halide lamps are used for display and flood light etc.

4) CFL Lamp :

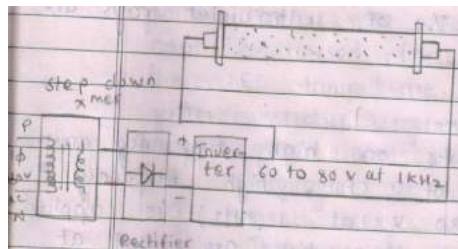

or equivalent figure

Explanation of CFL:

- The compact fluorescent lamps are as shown in figure; these lamps are available in various shapes.
- The CFL is always called as a energy saving lamps.
- The illumination efficiency of CFL is between the 50-60 lumens per watt.
- The life of the CFL is more than 3000 working hours and cost also less as compare to fluorescent tubes.
- The CFL are available in various colors.

Working of CFL:

- It works on high frequency emission for any type of CFL.
- High frequency AC Supply (60-80V at 1 KHz) is applied to the inert gases which are filled at low pressure.
- Then due to high frequency there will be ionization of mercury powder helium and other inert gases.
- And light is emitted through this fluorescent lamp.
- This high frequency is maintained constant throughout.



5) Fluorescent Lamp:

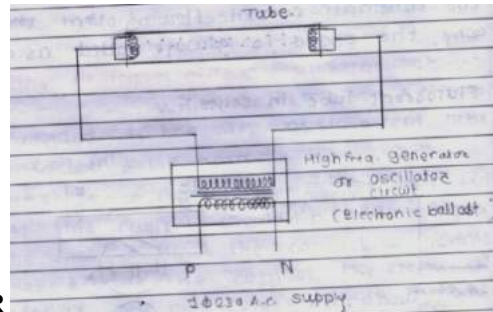
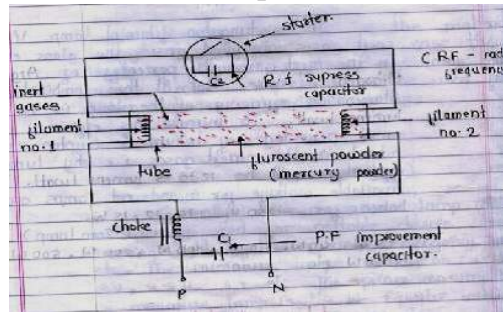

OR

Construction:-

Fluorescent tube consists of tube, choke, starter & power factor improvement capacitor.

Working operation:-

When switch is ON current flows through the choke-filament no1- starter-filament no. 2- to neutral, At that time choke induces high voltage which is applied to two filaments and ionized gas, Due to this there will be high voltage ionization so that light will be emitted through the tube. Choke is acting as ballast starter is used for make and break the circuit. To operate the fluorescent lamp, need a ballast (choke) to limit the current & provide the necessary starting voltage and starter for starting the tube.

6) LED Lamp explanation of construction & working:-

The working principle of LED is similar to diode (P-N junction) whenever DC current flows through the light emitting diode, if the current path is from anode to cathode there will be voltage drop across the diode. It is 1.5V to 2.1V then light will be emitted through this diode.

- The LED lamps are energy saving lamps,
- The power consumption of the single LED is very less. It is in mw. So by using series & parallel combination of LED.
- The LED lamp is manufactured the available wattage for the LED lamps are 1W,2W 3W, 5W etc.
- The LED lamps is available is various colours and diameter. The life of LED lamp is very high minimum 10000 working hours.

b) Explain any four factors that govern the design considerations for industrial premises.

Ans: Following four factors that govern the design considerations for industrial premises:



(Any Four point expected: 1 Mark each)

- **Comfortable:** The energy illumination scheme should be comfortable to everybody.
- **Pleasant surrounding:** By the electrical lighting or the electrical illumination scheme the surrounding area of that location should be pleasant.
- **Long life:** The life of the designed illumination should be large
- **Economy:** The cost of the designed illumination scheme be low.
- **Less Maintenance:** For only type of illumination scheme the maintenance and repairing should be less.
- **Appearance:** The appearance of illumination scheme should be good.
- **Less glare:** The glare is fatigue to the human eyes. The illumination scheme is designed in such away that there should be less glare to everyone i.e only electrical & mechanical accidents will be less.
- **Less flicker:** The flicker is change in light intensity. This flicker should be always less for any type of illumination scheme. In the flicker there are changes of stroboscopic effect at the time of workshop lighting it is very imp.
- **To avoid hard shadows:** The whole illumination scheme is designed for minimum shadows. At the time of flood light the hard shadows are avoided.
- **Sufficient lux level:** The lux level is decided by the type of applications, type of location & their countries standard
- **Cleanliness:** The illumination scheme should be free from any type of ash, smoke or any other air pollution it should be clean.
- **Simple control:** The illumination scheme designed by the electrical lighting is very simple. The control, multicolor light intensity control is also possible in electrical illumination.

OR

- 1) **Level of illumination or degree of illumination:** It depends on nature of work to be carry out. The degree of level of illumination also depends on following factors.
- i) The size of object & its distance from observer.
 - ii) If object is moving higher level of illumination is required than stationary object.
 - iii) If the objects are required to be seen for long duration of time, higher level of



illumination is necessary & for stair cases, corridors less illumination is required.

- 2) **Glare:** The glare causes unnecessary eye fatigue so it must be avoided, it can be prevented by using diffusing glass screen, suitable reflectors & proper mounting height. Reflected glare from the polished surfaces within the line of vision should be avoided.
- 3) **Shadows:** The formation of long and hard shadows must be avoided. The long and hard shadows cause accident. Such shadows can be avoided by
- i) Using proper mounting height of the lamps. ii) Using more number of lamps & providing indirect lighting. iii) Employing wide surface sources of light.
- Complete absence of shadows is again not recommended as soft shadows are required to identify three dimensional objects.
- 4) **color rendering:** This refers to the ability of the light source to reproduce the original colour of the objects when the object is illuminated by that source.
- 5) **Lamp fittings:** The lamp fittings serve the following functions in good illumination scheme.
- i) To diffuse the light ii) To cut off the light at certain angle to avoid glare iii) To give mechanical protection to light source. iv) To increase the aesthetical requirement of the premises. V) To control the level of light (control gear)
- 6) **Maintenance:** Regular cleaning of lamps & light fittings is necessary to maintain their efficiency. The maintenance is necessary against dust, water leakage, dangerous gases which may cause corrosion of light fittings. Hence light fittings should be simple & easy from maintenance point of view.
- 7) Following factors are consider while designing interior illumination: utilization factor, deprecation factor, Maintenance factor and space to height ratio

OR

Factors while designing interior location industrial unit:-

(Any Eight points expected, each point -1/2 Mark)

- 1) The type of industry or factory.
- 2) The total premises area of the whole factory in m^2 .
- 3) The location of the factory.
- 4) The surrounding conditions. e.g. wind pressure, natural sun light, rainfall, etc.
- 5) The type of product which are manufactured in the factory.
- 6) The total indoor & outdoor area of the given factory.
- 7) The necessary lux level for the outdoor locations to increase the beauty of the factory at night, and pleasant working conditions.
- 8) The working plane required for the indoor application whether it is a ground surface



	<p>or above ground surface.</p> <p>9) The application of every room in the given factory. e.g. office, workshop, Research & development centre, testing centre, maintenance & repairing department, quality control department, sales department, commissioning department, showroom, guest room etc.</p> <p>10) The required lux level for indoor premises in the given factory is decided as per application of department. e.g. In Workshop - 200 lux, e.g. In Showroom - 350 lux Above lux level is assumed.</p> <p>11) As per civil construction work, the colour of ceiling walls & machines. The waste Light factor, utilization factor & depreciation factor is decided.</p> <p>12) To minimize the stroboscopic effect & to minimize the glare the combination of various types of lighting source are selected.</p> <p>13) The location & mounting of light source are selected in such a way that electrical & mechanical accident will be less.</p> <p>14) The maintenance and repairing work for the whole illumination scheme should be less.</p> <p>15) The overall cost of the illumination scheme should be less.</p> <p>16) The lighting sources are selected in such a way that the overall power consumption will be less.</p> <p>17) The lighting sources are selected and the illumination scheme is designed in such a way that the replacement of lighting accessories will be simple.</p> <p>18) If expansion is required then it should be possible in present illumination scheme.</p>
c)	What is flood lighting? State various purposes of flood lighting.
Ans:	Flood Lighting: (2 Marks) Flood lighting means flooding of large surface area with light from powerful sources using projector



	<p>Various purpose of flood lighting: (2 Marks)</p> <ol style="list-style-type: none">1) Aesthetic flood Lighting : It is used for buildings at night, ancient building and monuments, churches & gardens etc2) Industrial & Commercial Flood lighting: It is used for illuminating railway yards, stadiums, car parking area etc.3) Advertising flood lighting: It is used for illuminating advertisements, boarding's etc <p style="text-align: center;">OR</p> <ol style="list-style-type: none">1. It is used for buildings at night, ancient building and monuments, churches & gardens etc2. It is used for illuminating railway yards, stadiums, car parking area etc.3. It is used for illuminating advertisements, boarding's etc																											
d)	State the recommended illumination level required for any four area of residential premises.																											
Ans:	<p>Recommended illumination level required for any four area of residential premises. (Any Four Point expected : 1 Mark)</p> <table border="1"><thead><tr><th>S.No</th><th>Places of residential Purpose</th><th>illumination level in lux</th></tr></thead><tbody><tr><td>i</td><td>Living Room</td><td>300 Lux</td></tr><tr><td>ii</td><td>Bedroom</td><td>200 Lux</td></tr><tr><td>iii</td><td>Kitchen</td><td>150 to 200 Lux</td></tr><tr><td>iv</td><td>Stairs</td><td>60 to 100 Lux</td></tr><tr><td>v</td><td>Dining Room</td><td>150 Lux</td></tr><tr><td>vi</td><td>Dressing table</td><td>200 Lux</td></tr><tr><td>vii</td><td>Bathroom mirror</td><td>70 Lux</td></tr><tr><td>viii</td><td>Study table</td><td>300 Lux</td></tr></tbody></table>	S.No	Places of residential Purpose	illumination level in lux	i	Living Room	300 Lux	ii	Bedroom	200 Lux	iii	Kitchen	150 to 200 Lux	iv	Stairs	60 to 100 Lux	v	Dining Room	150 Lux	vi	Dressing table	200 Lux	vii	Bathroom mirror	70 Lux	viii	Study table	300 Lux
S.No	Places of residential Purpose	illumination level in lux																										
i	Living Room	300 Lux																										
ii	Bedroom	200 Lux																										
iii	Kitchen	150 to 200 Lux																										
iv	Stairs	60 to 100 Lux																										
v	Dining Room	150 Lux																										
vi	Dressing table	200 Lux																										
vii	Bathroom mirror	70 Lux																										
viii	Study table	300 Lux																										
e)	Explain the importance of mounting height and spacing of luminaries while designing the lighting scheme for outdoor application.																											
Ans:	<p>The importance of mounting height and spacing of luminaries while designing the lighting scheme for outdoor application: (Any Four point expected: 1 Mark each)</p> <ol style="list-style-type: none">1. To create a visual environment space to height ratio is important.2. Space to height ratio is important from the point of illumination level required according to recommendation.																											



3. Space to height ratio is important according to requirement/application e.g. street lighting, open parking, security lighting, landscape accent lighting, Sign lighting and garden lighting etc.
4. Space to height ratio is important from the point of light pollution.
5. Space to height ratio is important from the point of vertical & horizontal illumination.
6. It is important from the point of view to obtained shadow less light.
7. It is important to obtained glare free lighting. (To avoid discomfort).
8. It is important to avoid overlapping of light.
9. It is important from the CRI (Colour rendering index) point of view.
10. It is important from the point of view co-related to CCT (Colour Temperature)
11. It is important from the point of operating environment (atmosphere)
12. It is important from the point of aesthetic point of view.
13. It is important from the point of energy efficiency & saving and maximum utilization factor.
14. It is important from the point of safety against road traveling.
15. It is important from the point of method of lighting (direct or indirect).
16. It is important for the point of type and physical size of luminaries.

-----END-----