



MODEL ANSWER

SUMMER- 18 EXAMINATION

Subject Title: Processes Equipments

Subject Code: **17457**

Important Instructions to examiners:

- 1) The answers should be examined by key words and not as word-to-word as given in the model answer scheme.
- 2) The model answer and the answer written by candidate may vary but the examiner may try to assess the understanding level of the candidate.
- 3) The language errors such as grammatical, spelling errors should not be given more importance. (Not applicable for subject English and Communication Skills)
- 4) While assessing figures, examiner may give credit for principal components indicated in the figure. The figures drawn by candidate and model answer may vary. The examiner may give credit for any equivalent figure drawn.
- 5) Credits may be given step wise for numerical problems. In some cases, the assumed constant values may vary and there may be some difference in the candidate's answers and model answer.
- 6) In case of some questions credit may be given by judgment on part of examiner of relevant answer based on candidate's understanding.
- 7) For programming language papers, credit may be given to any other program based on equivalent concept.

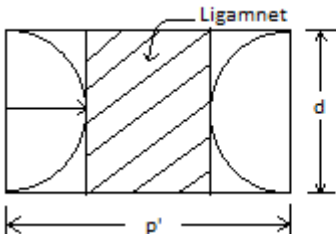
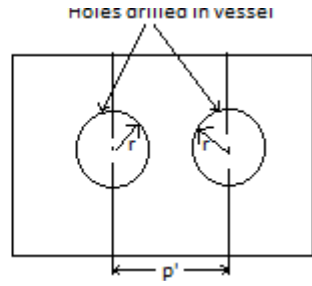
| Q. NO. | ANSWER | Marking scheme |
|--------|---|---|
| 1 | Attempt any <u>Five</u> of the following | 5 x 4 |
| a) | <p>Ligament Efficiency :</p>   <p>Ligament efficiency is defined as the ratio of area of ligament to the area of normal section. Ligament Efficiency= (Area of ligament X Area of Ligament)/ 100</p> | <p>02 Marks-diagram</p> <p>02 Marks</p> |
| b) | <p>Fatigue concentration:</p> <p>Stress concentrations produced by irregularities are damaging in case of fluctuating stresses. All failures as a result of fatigue are in the areas of high localized stresses. Hence all stresses including localized stresses should be taken into account when designing the pressure vessel.</p> | 04 marks |



MODEL ANSWER

SUMMER- 18 EXAMINATION

Subject Title: Processes Equipments

Subject Code: **17457**

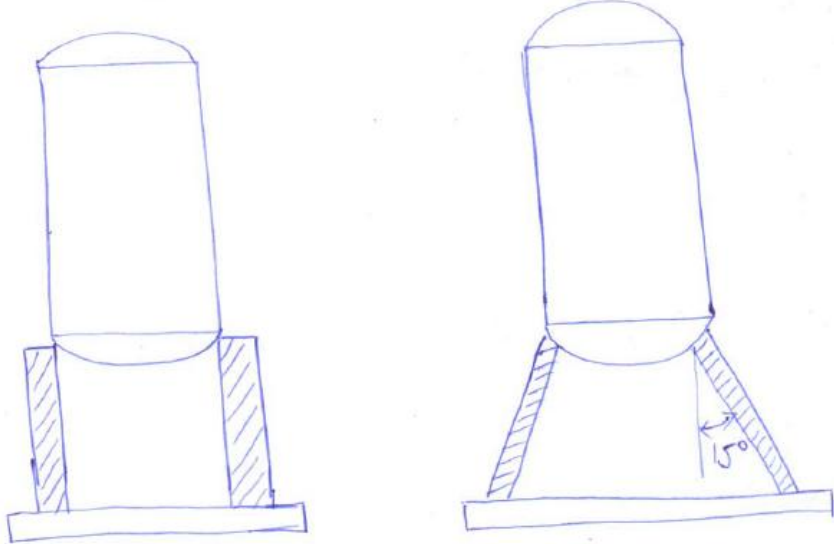
| | | |
|------------------|---|--|
| <p>c)</p> | <p>Design Pressure:</p> <p>It is the pressure used to determine the minimum required thickness of each vessel shell component. It denotes the difference between internal and external pressure</p> $P_{\text{design}} = P_{\text{internal}} - P_{\text{external}}$ <p>(P external is negligible)</p> <p>Therefore, P design = P internal</p> | <p>04 marks</p> |
| <p>d)</p> |  <p>(i) straight type</p> <p>(ii) Flared type skirt support</p> | <p>04 Marks</p> |
| <p>e)</p> | <p>Multi shell construction</p> <ul style="list-style-type: none">- These vessels are built up by wrapping series of sheets over a core tube. The construction involves the use of several layers material usually for the purpose of quality control and optimum property and for safety purpose- Each layer must be sufficiently thick and is considered as thick walled cylinders.- For corrosive application, the inner layer is made special material and is not considered for strength criteria- The outer load bearing shells cab be made of high tensile | <p>Any Four</p> <p>1 Mark for each</p> |



MODEL ANSWER

SUMMER- 18 EXAMINATION

Subject Title: Processes Equipments

Subject Code: **17457**

| | | |
|-----------|--|--------------------------------------|
| | carbon steel - These vessel are constructed up to (1)230MPa (2)400 ^o c to -20 ^o c (3)300mm thickness wall. | |
| f) | Design Consideration for Pressure Vessel: 1) Proper selection of Factor of Safety (F.O.S.). 2) Proper material Selection: There is no perfect pressure vessel material suitable for all environments, but material selection must match application & environment. This is especially important in chemical reactors because of embrittlement effect of gaseous absorption and in nuclear reactors because of the irradiation damage from neutron bombardment(attack). 3) Need of Heat Treatment: Proper heat treatment is used to improve qualities/properties of materials by reducing their cost. 4) Economy: Design Engineers should be cautious to control the cost of the product. | 4 Marks 1 Mark Each |
| g) | Poisson ratio is the ratio of lateral strain to the linear strain within the elastic limit for a given material. It is denoted by μ and for pressure vessel material, assume $\mu=0.3$ | 04 Marks |
| h) | The factors considered for selection of material for hydrogen services: 1) Temperature 2) Hydrogen pressure 3) Time 4) Composition of material | 04 Marks |
| 2 | Attempt any <u>Two</u> of the following | 8 x 2 |
| a) | Ferrous metals used for corrosive services in pressure vessel construction: <ul style="list-style-type: none">• Wrought iron• Cast iron<ul style="list-style-type: none">a. Grey cast ironb. White cast iron | 08 Marks |



MODEL ANSWER

SUMMER- 18 EXAMINATION

Subject Title: Processes Equipments

Subject Code: **17457**

| | |
|---|--|
| <p>c. Alloy cast iron</p> <p>High silicon iron</p> <p>High silicon cast iron with nickel and copper</p> <p>Nickel alloy cast iron</p> <ul style="list-style-type: none">• Steel<ul style="list-style-type: none">a. Low carbon steelb. Medium carbon steelc. High carbon steeld. Alloy steel <p>Low alloy steel viz. Carbon Molybdenum steels</p> <p>High alloy steels viz. Chromium steels, Chromium nickel steels also called as Stainless steels</p> <p>Commonly used material is Low carbon steels <u>or</u> also called Mild steels:</p> <p>Properties:</p> <ul style="list-style-type: none">• Good strength and ductility• Good weldability, machinability and fabricability• Rolled, forged and drawn• Low corrosion resistance <p>Application: Used in normalized condition for;</p> <ul style="list-style-type: none">• Pressure vessel components,• Pipes and fittings,• Machine components,• Structural sections,• etc. | |
|---|--|

MODEL ANSWER
SUMMER- 18 EXAMINATION

Subject Title: Processes Equipments

Subject Code: **17457**

b) Stress concentration due to circular and elliptical openings:

$$K_t = \sigma_3 / \sigma_{av}; \text{ where}$$

$$\sigma_{av} = P/t(w-2b)$$

$$\sigma_1 = P/tw$$

$$\sigma_3 = \sigma_1(1 + 2b/a)$$

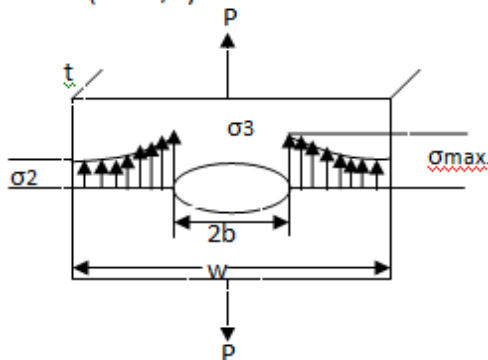

| b/a | K _t |
|-----|----------------|
| 1 | 2.5 |
| 2 | 4.5 |
| 3 | 6.5 |
| 1/2 | 1.5 |
| 1/3 | 2.5 |
| 1/4 | 3.5 |
| 1/5 | 4.5 |

Where, b/a = 1 refers to circular opening
b/a = 1/2 refers to vertical ellipse with least stress concentration, K_t

Vertical ellipse openings are preferred since, K_t is less. Elliptical openings are used for special purpose such as hand hole openings and is selected so as to allow the insertion of a pressure sealing cover plate through its own opening. It can also be used as a shape of nozzle.

03 marks for figure
&
03 marks for table

02 marks

c)

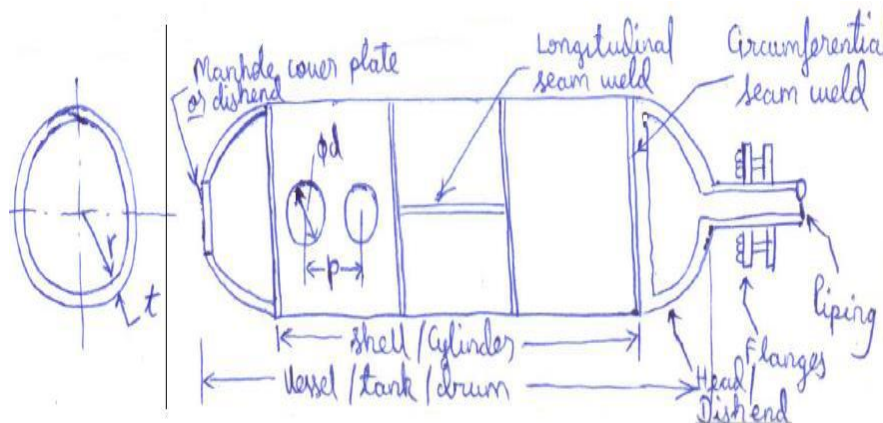

Pressure vessel consists of basic parts such as;

- 1) Shell
- 2) Head
- 3) Nozzle

03 marks diagram

05 marks explanation



MODEL ANSWER

SUMMER- 18 EXAMINATION

Subject Title: Processes Equipments

Subject Code: **17457**

| | | |
|-----------|--|-----------------|
| | <p>4) Baffle Plates 5) Supports (Rings) 6) Piping, etc.</p> <p>Cylinders/shell:- it is the container which holds the fluid under pressure and temperature</p> <p>Rings: - these are used so that leakages at the joints in the pressure vessel are avoided</p> <p>Baffle plates: - these used to increase the pressure in boiler or pressure vessel. The position of these plates varies the pressure in vessel.</p> <p>Curved shape dish ends/ heads/ closure ends: - these are ends which provide closure to the vessel. The shape of the ends varies according to the use.</p> <p>Nozzles: - these are the outlet/inlet hole which is used for the supply of the fluid.</p> <p>Flanges: - these are used to connect the pipes with the vessel so that minimum losses are achieved.</p> <p>Piping: - these are used so that the fluid can be transferred from the vessel</p> | |
| 3 | Attempt any <u>Four</u> of the following | 4 X 4 |
| a) | <p><u>Visual inspection:</u></p> <p>Visual-weld-inspection represents the immediate critical observation of the external features visible on all welds. It is the first and most important assessment of quality to be performed as soon as the welding operations are accomplished.</p> <p>Other inspection procedures may be required to detect discontinuities not visible to the eye or present below the external surface. Whatever additional non destructive inspection methods are applied, they are performed only after visual inspection is successfully completed.</p> | 03 Marks |



MODEL ANSWER

SUMMER- 18 EXAMINATION

Subject Title: Processes Equipments

Subject Code: **17457**

| | | |
|------------------|---|--------------------------------------|
| | <p>The List of NDT methods:</p> <ol style="list-style-type: none">1) Liquid Penetrant Testing2) Magnetic Particle Testing3) Ultrasonic Testing4) Radiographic Testing | <p>01 mark</p> |
| <p>b)</p> | <p>Ferrous metals used for corrosive services in pressure vessel construction:</p> <ul style="list-style-type: none">• Wrought iron• Cast iron<ol style="list-style-type: none">a. Grey cast ironb. White cast ironc. Alloy cast iron<p>High silicon iron</p><p>High silicon cast iron with nickel and copper</p><p>Nickel alloy cast iron</p>• Steel<ol style="list-style-type: none">a. Low carbon steelb. Medium carbon steelc. High carbon steeld. Alloy steel<p>Low alloy steel viz. Carbon Molybdenum steels</p><p>High alloy steels viz. Chromium steels, Chromium nickel steels also called as Stainless steels</p><p>Commonly used material is Low carbon steels <u>or</u> also called Mild steels:</p><p>Properties:</p> | <p>Any 1 type 01 Mark</p> |



MODEL ANSWER

SUMMER- 18 EXAMINATION

Subject Title: Processes Equipments

Subject Code: **17457**

| | |
|--|--------------------------------------|
| <ul style="list-style-type: none">• Good strength and ductility• Good weldability, machinability and fabricability• Rolled, forged and drawn• Low corrosion resistance• etc. <p>Application: Used in normalised condition for;</p> <ul style="list-style-type: none">• Pressure vessel components,• Pipes and fittings,• Machine components,• Structural sections,• etc. <p>Non ferrous metals used for corrosive services in pressure vessel construction:</p> <ul style="list-style-type: none">• Aluminium and alloys• Copper and alloys• Nickel and alloys• Chromium and alloys• Lead• Titanium• Beryllium• Zirconium• Tantalum <p>Commonly used materials are Copper and Nickel and their alloys:</p> <p>Properties:</p> <ul style="list-style-type: none">• Good ductility and malleability• Good electrical and thermal conductivity• Good mechanical strength and fabricability• Good resistance to atmospheric attack, strong alkalies and organic solvents• etc. | <p>Any 1 type 01 Mark</p> |
|--|--------------------------------------|



MODEL ANSWER

SUMMER- 18 EXAMINATION

Subject Title: Processes Equipments

Subject Code: **17457**

| | |
|---|---|
| <p>Application:</p> <ul style="list-style-type: none">• Copper alloys viz. Brass, Bronze, Aluminium bronze, Cu-Ni alloys for manufacture of process equipments• Nickel alloys viz. Monel, Inconel, Haste alloy for manufacture of process equipments and cladding purposes <p>etc.</p> <p>Methods of attaching protective coatings:</p> <p>1. Integral cladding- Low carbon steels or low alloy steels (base plates) also called as backing plates and corrosion resistant steel (liners) are welded at the edges. This is then passed through steel mills for hot rolling operations. The high temperature and high pressure creates a solid bond between the plates. Thickness of the liners is about 2mm to 4mm or 8% to 20% thickness of base metals.</p> <p>2. Sheet lining- The corrosion resistant layer is attached to a vessel shell by welding. Thickness of sheet is 2mm to 4mm. Types are;</p> <ul style="list-style-type: none">i) Strip type lining of 3' to 5' X 3" to 6" wide strips are welded on base material by spot welding.ii) Sheet type lining of several feet in length and width are welded on base materials by spot, plug or seam welding. The linings are attached to the vessel after the vessel is entirely completed. Sometimes sheets are attached to the base plates before rolling or forming. Carbon steel surfaces (base plates) are ground to provide suitable surface for application of the liner. <p>3. Protective coatings- Coatings should be applied only on clean surfaces free from grease, oil, dirt, scale, etc.</p> <ul style="list-style-type: none">i) Metallic coatings – Common methods are electroplating, mechanical cladding (most important), metal spraying, cementation, hot dipping, and condensation of metal vapors.ii) Inorganic coatings – Chemical dipped methods are used to create protective oxide films on iron, steel, stainless steel, copper, aluminum and some of their alloys. Such films are very thin and colored. e.g. Electrolytic coating.iii) Organic coating – Different synthetic resins, pigments, oils and solvents are used in coating formulations. A continuous adherent inert film is formed between the metal and environment. They change the appearance of the metal e.g. paint enamel, lacquer. | <p style="text-align: center;">02 Marks For any one type</p> |
|---|---|

MODEL ANSWER

SUMMER- 18 EXAMINATION

Subject Title: Processes Equipments

Subject Code: **17457**

c) Sphere:

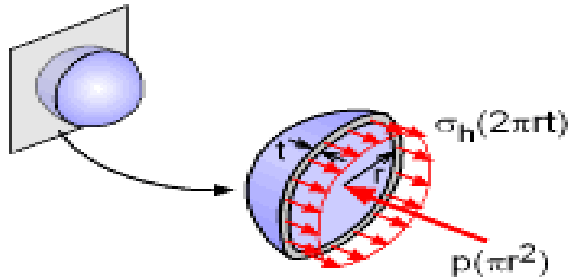

**Spherical Pressure Vessel
Cut in Half**

A spherical pressure vessel is really just a special case of a cylindrical vessel. No matter how the sphere is cut in half, the pressure load perpendicular to the cut must equal the shell stress load. This is the same situation with the axial direction in a cylindrical vessel. Equating the two loads gives;

$$p(\pi r^2) = \sigma_h (2\pi r t)$$

This can be simplified to:

$$\sigma_h = \sigma_a = pr / 2t$$

(Notice, the hoop and axial stress are the same due to symmetry)

Ring:

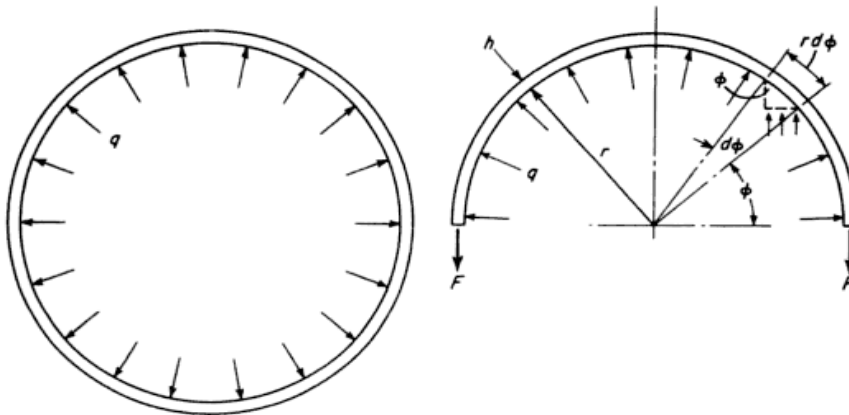

Radial and Hoop Stresses in a Thin Ring

If a thin circular ring is subjected to the action of radial forces uniformly distributed along its circumference, hoop forces will be produced throughout its thickness which act in a tangential direction. A uniform enlargement of the ring will take place if the acting forces are radial outward, or contraction will occur if the

01 Mark

01 Mark

01 Mark

01 Mark



MODEL ANSWER

SUMMER- 18 EXAMINATION

Subject Title: Processes Equipments

Subject Code: **17457**

acting forces are radial inward. The magnitude of the force F in the ring can be found by cutting the ring at a horizontal diametrical section giving the free body shown in Fig. . If the force per unit length of circumference is q , and r is the radius of the ring, the force acting on an element of the ring is $qr d\phi$. Taking the sum of the vertical components of all the forces acting on the semicircular ring gives the equilibrium equation:

$$2F = 2 \int_0^{\pi/2} qr \sin \phi d\phi = 2qr$$

$$F = qr$$

The unit stress in the ring can be obtained by dividing the force F by the cross-sectional area A of the ring.

$$\sigma_2 = \frac{qr}{A}$$

Now, $r \sin \phi d\phi$ is the projection of a circumferential element on a diameter; hence the right side of Equation. is merely the unit force times the projected length of the contact surface.

If the ring is considered a section of unit length of a cylindrical vessel of thickness h subjected to internal pressure p , so that in Equation. $q = p$ and $A = h$, the hoop stress in a cylindrical vessel becomes

$$\sigma_2 = \frac{pr}{h}$$

MODEL ANSWER
SUMMER- 18 EXAMINATION

Subject Title: Processes Equipments

Subject Code: **17457**

d) Methods of reducing stress concentration

04 Marks

Attempt Any Two

02
Marks for Each

1.

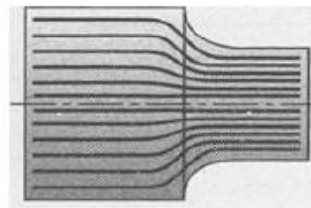
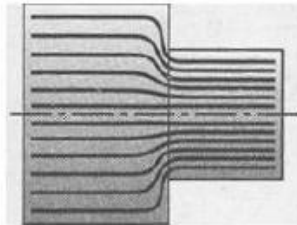

(a) Force flow around a sharp corner

Force flow around a corner with fillet:
Low stress concentration.

2.

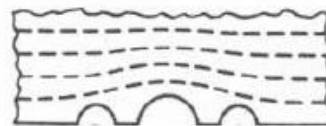
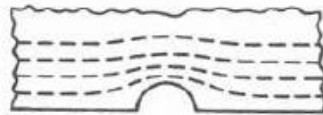

(b) Force flow around a large notch

Force flow around a number of small notches:
Low stress concentration.

3.

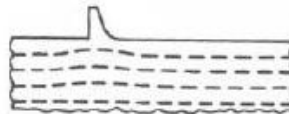
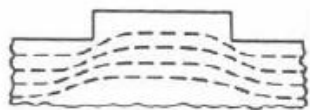

(c) Force flow around a wide projection

Force flow around a narrow projection:
Low stress concentration.

4.

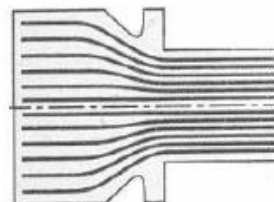
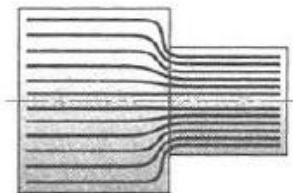

(d) Force flow around a sudden
change in diameter in a shaft

Force flow around a stress relieving groove.

5. Step and sharp corners be eliminated

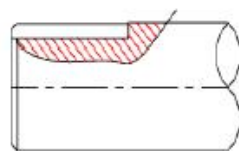

Better

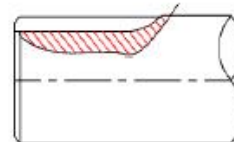

6. Selecting materials which are tolerant to cyclic loading (ductile /tough materials)

MODEL ANSWER

SUMMER- 18 EXAMINATION

Subject Title: Processes Equipments

Subject Code: **17457**

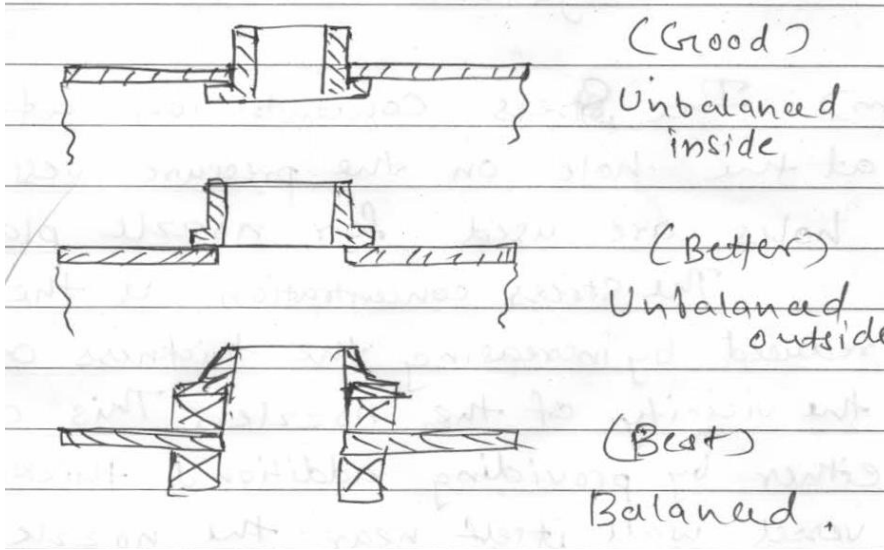
| | | |
|-----------|--|---|
| <p>e)</p> |  <p>(Good) Unbalanced inside</p> <p>(Better) Unbalanced outside</p> <p>(Best) Balanced</p> <p>Stress concentration is formed at the hole on the pressure vessel. These holes are used for nozzle placement.</p> <p>The stress concentration at the hole can be reduced by increasing the thickness of the vessel in the vicinity of the nozzle. This can be done either by providing additional thickness to the vessel wall itself near the nozzle or by use of separate reinforcing plate attached to the vessel wall covering an area surrounding the hole. Sometimes the nozzle wall at base can be made sufficiently thick to act as reinforcement.</p> | <p>02 Marks diagram</p> <p>02 Marks</p> |
| <p>f)</p> | <p>Factors governing for:</p> <p>(i) Double bevel butt weld</p> <ul style="list-style-type: none"> - Thickness of weld metal - Angle of bevel as per thickness - Length of root face - Proper penetration of root run of weld <p>(ii) Fillet Weld</p> <ul style="list-style-type: none"> - Amount of overlap of plates - Tensile stress - Leg size of weld - Throat thickness of weld | <p>02 Marks</p> <p>02 Marks</p> |



MODEL ANSWER

SUMMER- 18 EXAMINATION

Subject Title: Processes Equipments

Subject Code: **17457**

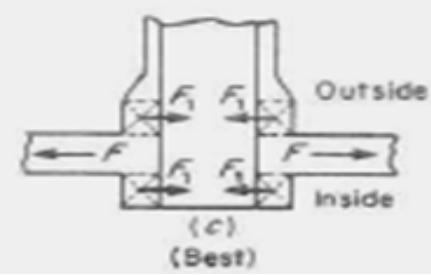
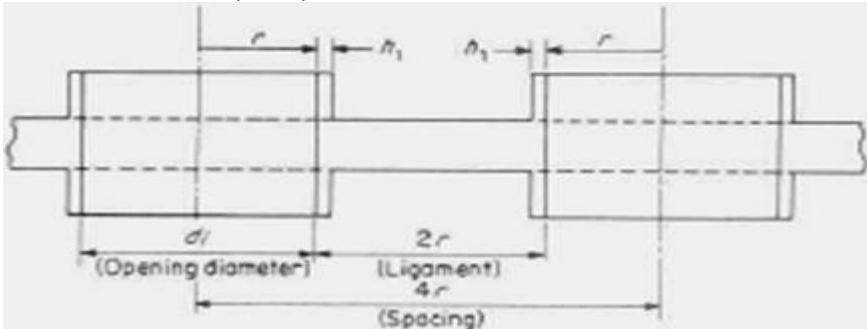
| | | |
|-------------|--|--|
| 4 | Attempt any <u>Two</u> of the following | 8 x 2 |
| a) i | Nozzle can be classified as follows (A) By the use 1. Single 2. Multiple 3. Non radial (B) By make 1. Integral nozzle 2. Fabricated nozzle 3. Formed nozzle | 02 marks 02 marks |
| ii | Nozzle placement: 1. Single nozzles Minimum stress concentration factor is obtained with balanced reinforcement explainable by the fact that reinforcing material evenly disposed both inside and outside of the vessel surface introduces no eccentricity or unbalance to create local bending moments and stresses.  2. Multiple nozzle arrangements Multiple reinforced nozzle arrangements require special consideration when they are very closely spaced because their individual effects become overlapping and the average membrane stress in the vessel wall are not increased by the presence of reinforced nozzles.  | 04 marks for any one type |



MODEL ANSWER
SUMMER- 18 EXAMINATION

Subject Title: Processes Equipments

Subject Code: **17457**

3. Non radial nozzles

A non-radial nozzle may be installed for a functional purpose and not commonly used. A non-radial circular nozzle makes an elliptical opening in the vessel and just as an elliptical hole in a plate gives rise to a higher stress concentration factor than does a circular hole, so does a non-radial nozzle have higher stress concentration factor than its comparable radial one.

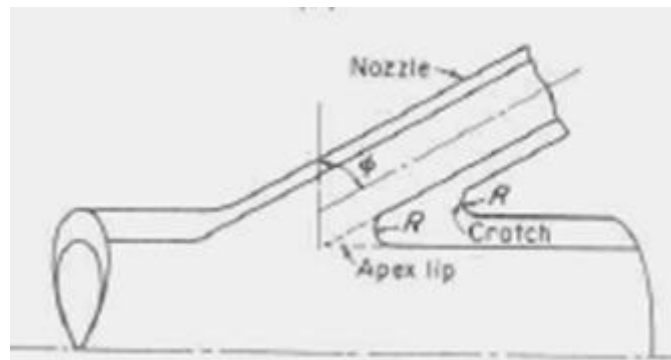

Nozzle shape:

Nozzles may be circular, elliptical or oval in shape

| b/a | Kt |
|------------|------------|
| 1 | 2.5 |
| 2 | 4.5 |
| 3 | 6.5 |
| 1/2 | 1.5 |
| 1/3 | 2.5 |
| 1/4 | 3.5 |
| 1/5 | 4.5 |

2b = Major axis and 2a = Minor axis

Where, b/a = 1 refers to circular opening

b/a = 1/2 refers to vertical ellipse with least stress concentration, Kt

MODEL ANSWER

SUMMER- 18 EXAMINATION

Subject Title: Processes Equipments

Subject Code: **17457**

b)

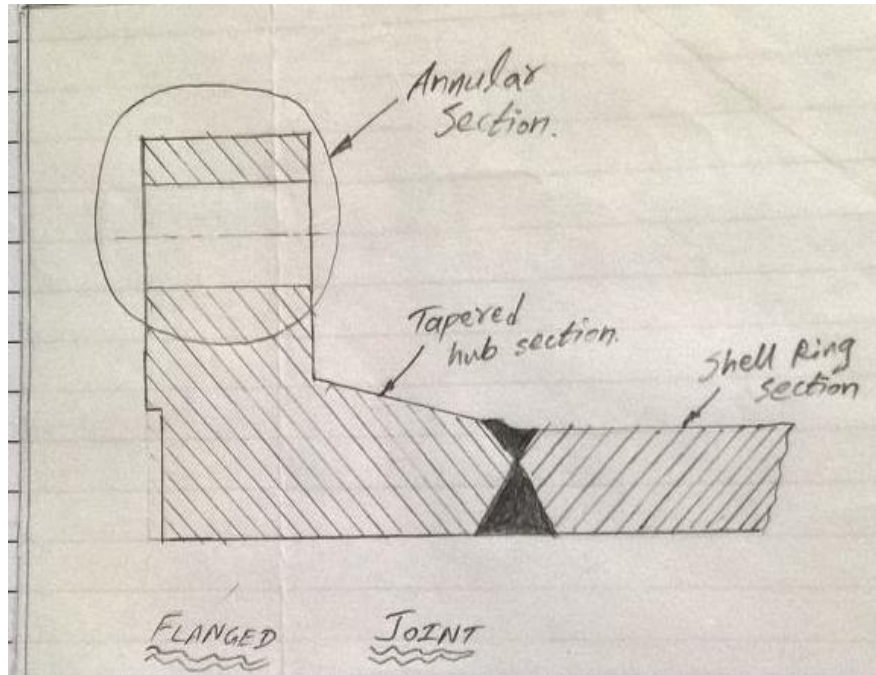

02 marks for diagram

Different stresses acting on flanged joint:

Consider the Flange as divided into three sections viz.

- Annular ring section:

1. Overturning moment, acting on the ring, due to non-concentricity of the bolt load and gasket reaction load is replaced by two equal and opposite forces.

2. Internal hydrostatic pressure

- Tapered hub section

1. Shear force and bending moment

2. Internal hydrostatic pressure

- Shell ring section

1. Discontinuity shear force and bending moment

**02 marks for
explanation**

MODEL ANSWER
SUMMER- 18 EXAMINATION

Subject Title: Processes Equipments

Subject Code: **17457**

Types of gaskets according to the properties and shapes used in pressure vessels are;

- Flat ring
- Serrated
- Laminated
- Corrugated
- etc.

For low temperature services; rubber, plastic, paper, cork, asbestos, fiber, etc. are used as gasket materials e.g. Most common is 'O' ring which is used in flanges, cylindrical end caps, fittings, plugs, etc. Pressures up to 30000 PSI can be sealed by using 'O' rings.

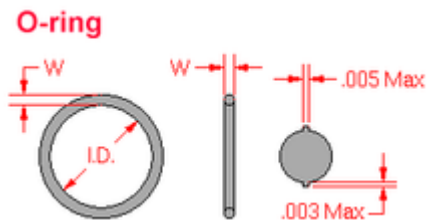

For high temperature service; flat metallic materials like Cu, Ag, Au, etc. are used as gasket materials. They are available in variety of shapes e.g. oval, octagonal, hexagonal, etc.

Corrugated metal gaskets



02 marks for classification

02 marks for examples



MODEL ANSWER

SUMMER- 18 EXAMINATION

Subject Title: Processes Equipments

Subject Code: **17457**

| <p>c)</p> | <p>Given data: $P = 13 \text{ N/mm}^2$ $D_i = 150 \text{ mm}$, $R_i = D_i/2 = 75 \text{ mm}$ $E = 100\% = 1$ (assume since not mentioned) $S = 23 \text{ MPa} = 23 \text{ N/mm}^2$</p> <p>To find (i) thickness of cylindrical shell (ii) Thickness of flat head</p> <p>Calculation:</p> <p>1) Thickness of shell:</p> $t = (P \cdot R_i) / (SE - 0.6P)$ $= (13 \cdot 75) / (23 \cdot 1 - 0.6 \cdot 13)$ $= (975) / (23 - 7.8)$ $= (975) / (15.2)$ $= 64.14 \text{ mm}$ <p>Consider the chart:</p> <table border="1" data-bbox="272 1367 1154 1780"><thead><tr><th>VESSEL DIAMETER (m)</th><th>MINIMUM SHELL THICKNESS(mm)</th></tr></thead><tbody><tr><td>Upto 1.0</td><td>5</td></tr><tr><td>Above 1.0 to 2.0</td><td>7</td></tr><tr><td>Above 2.0 to 2.5</td><td>9</td></tr><tr><td>Above 2.5 to 3.0</td><td>10</td></tr><tr><td>Above 3.0 to 3.5</td><td>12</td></tr></tbody></table> <p>So shell thickness as per chart is suggested as 5mm</p> | VESSEL DIAMETER (m) | MINIMUM SHELL THICKNESS(mm) | Upto 1.0 | 5 | Above 1.0 to 2.0 | 7 | Above 2.0 to 2.5 | 9 | Above 2.5 to 3.0 | 10 | Above 3.0 to 3.5 | 12 | <p>04 Marks</p> |
|---------------------|---|---------------------|-----------------------------|----------|---|------------------|---|------------------|---|------------------|----|------------------|----|------------------------|
| VESSEL DIAMETER (m) | MINIMUM SHELL THICKNESS(mm) | | | | | | | | | | | | | |
| Upto 1.0 | 5 | | | | | | | | | | | | | |
| Above 1.0 to 2.0 | 7 | | | | | | | | | | | | | |
| Above 2.0 to 2.5 | 9 | | | | | | | | | | | | | |
| Above 2.5 to 3.0 | 10 | | | | | | | | | | | | | |
| Above 3.0 to 3.5 | 12 | | | | | | | | | | | | | |



MODEL ANSWER

SUMMER- 18 EXAMINATION

Subject Title: Processes Equipments

Subject Code: **17457**

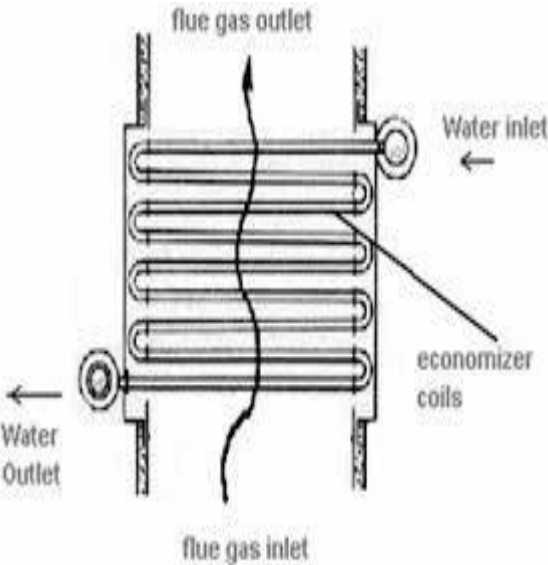
| | | |
|------------------|---|---|
| | <p>But designed value is obtained as 64.14 mm Consider the larger value of 64.14 mm ~ 66 mm Now, consider the rounded off even value 66mm as thickness of shell for further calculations</p> <p>2) Thickness of Flat Head: Flat head: $t = CD \sqrt{p/S}$ Here, D= Diameter of plate= Internal Diameter of shell= 150 mm C= Constant (Ranging from 0.4 to 0.7) – hence assume Maximum i.e. 0.7 Thus $t = (0.7 \times 150) \times (\sqrt{13/23})$ $= 78.93 \text{ mm}$ ~ 80 mm Consider the rounded off even value 80mm as thickness of Flat head</p> | <p>04 Marks</p> |
| <p>5</p> | <p>Attempt any <u>Four</u> of the following</p> | <p>4 X 4</p> |
| <p>a)</p> | <p>Boiler Accessories: • Economizer</p>  | <p>04 Marks for any one sketch</p> |

MODEL ANSWER
SUMMER- 18 EXAMINATION

Subject Title: Processes Equipments

Subject Code: **17457**

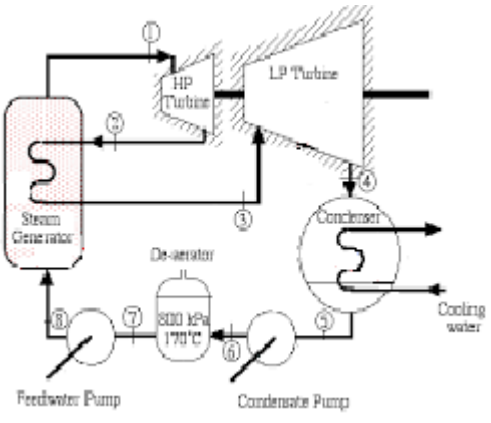
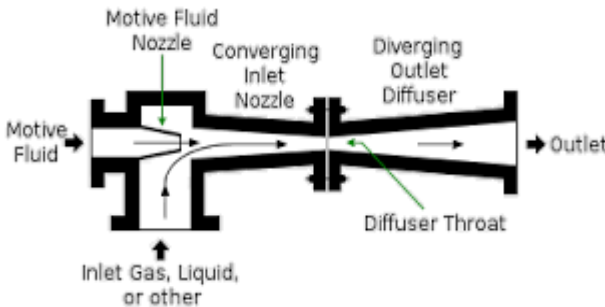
| | | |
|--------------------|---|---|
| | <ul style="list-style-type: none"> • Feed Water Pump  <ul style="list-style-type: none"> • Steam Injector  | |
| <p>b) i</p> | <p>Methods of attaching protective coatings:</p> <p>1. Integral cladding -Low carbon steels or low alloy steels (base plates) also called as backing plates and corrosion resistant steel (liners) are welded at the edges. This is then passed through steel mills for hot rolling operations. The high temperature and high pressure creates a solid bond between the plates. Thickness of the liners is about 2mm to 4mm or 8% to 20% thickness of base metals.</p> <p>2. Sheet lining -The corrosion resistant layer is attached to a vessel shell by welding. Thickness of sheet is 2mm to 4mm. Types are;</p> <p>i) Strip type lining of 3' to 5' X 3" to 6" wide strips are welded on base material by spot welding.</p> <p>ii) Sheet type lining of several feet in length and width are welded on base materials by spot, plug or seam welding. The linings are attached to</p> | <p>Any one method</p> <p>02 marks</p> |



MODEL ANSWER

SUMMER- 18 EXAMINATION

Subject Title: Processes Equipments

Subject Code: **17457**

| | | |
|----|--|-----------------------------------|
| | <p>the vessel after the vessel is entirely completed. Sometimes sheets are attached to the base plates before rolling or forming. Carbon steel surfaces (base plates) are ground to provide suitable surface for application of the liner.</p> <p>3. Protective coatings - Coatings should be applied only on clean surfaces free from grease, oil, dirt, scale, etc.</p> <p>i) Metallic coatings – Common methods are electroplating, mechanical cladding (most important), metal spraying, cementation, hot dipping, and condensation of metal vapors.</p> <p>ii) Inorganic coatings – Chemical dipped methods are used to create protective oxide films on iron, steel, stainless steel, copper, aluminum and some of their alloys. Such films are very thin and colored. e.g. Electrolytic coating.</p> <p>iii) Organic coating – Different synthetic resins, pigments, oils and solvents are used in coating formulations. A continuous adherent inert film is formed between the metal and environment. They change the appearance of the metal e.g. paint enamel, lacquer.</p> | |
| ii | <p>Use of Stainless Steel in Pressure Vessel:</p> <p>Stainless steels are any of the various steels alloyed with at least 10 percent chromium and sometimes containing other elements and that are resistant to corrosion or rusting associated with exposure to water and moist air.</p> <p>Types are;</p> <ul style="list-style-type: none">• Austenitic stainless steel• Martensitic stainless steel• Ferritic stainless steel• Ferritic Austenitic stainless steel• Nitrogen added stainless steel <p>Resistance to corrosion and staining, low maintenance and familiar lustre are some reasons to being used in pressure vessel construction.</p> | 02 Marks |
| c) | <p>Stress Concentration:</p> <p>Mechanical parts and structural elements often have features that cause sudden changes in geometry. Under loads, these changes in geometry increase the local stress fields of the parts quite significantly, and they usually represent locations from which parts start to fail. This localization of high stresses is called stress concentration</p> | 04 Marks for any 4 methods |



MODEL ANSWER
SUMMER- 18 EXAMINATION

Subject Title: Processes Equipments

Subject Code: **17457**

Effects of stress concentration in design of pressure vessel

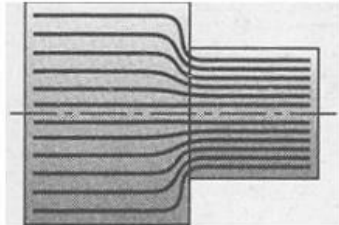

(a) Force flow around a sharp corner

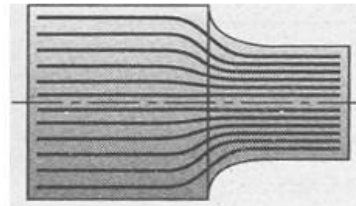

Force flow around a corner with fillet:
Low stress concentration.

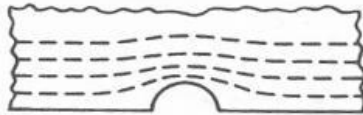

(b) Force flow around a large notch



Force flow around a number of small notches:
Low stress concentration.

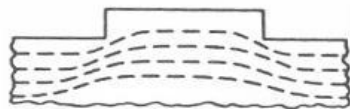

(c) Force flow around a wide projection



Force flow around a narrow projection:
Low stress concentration.

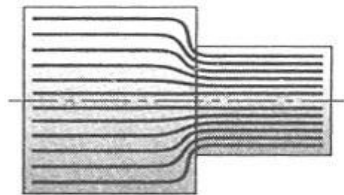

(d) Force flow around a sudden
change in diameter in a shaft

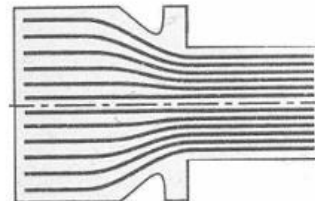

Force flow around a stress relieving groove.



MODEL ANSWER
SUMMER- 18 EXAMINATION

Subject Title: Processes Equipments

Subject Code: **17457**

| | | |
|------------------|--|--|
| | <p>-Steep and sharp corners be eliminated</p>  <p>-Selecting materials which are tolerant to cyclic loading (ductile /tough materials)</p> <p>- Specifying manufacturing processes to provide fatigue resistance (Peening /shot blasting/Cold Working)</p> <p>-Specifying heat treatment to provide fatigue resistance- (Carburising /Nitriding) or Overdesigning part to reduce stress Levels.</p> | |
| <p>d)</p> | <p>Weld defects for pressure vessel are as follows</p> <p><u>Misalignment:</u> Poor weld shape of weld occur due to misalignment of parts being welded. this also reduces the strength of weld</p> <p><u>Cracks:</u> Cracks in welds occur due to thermal shrinkage after the fused molten metal cools down.</p> <p><u>Pin Holes:</u> Pin holes on weld surface due insufficient flux covering or dirt on the parent metal.</p> <p><u>Slag Inclusion:</u> Slag inclusion occurs when slag covering a run is not totally removed after every run before the following run.</p> <p><u>Porosity:</u> Porosity occurs in the form of voids (cavity) when gases are trapped in the solidifying weld metal.</p> <p><u>Incomplete fusion:</u> Incomplete fusion between the weld and base metal resulting from too little heat input and / or too rapid traverse of the welding torch (gas or electric).</p> <p><u>Undercut groove:</u> Undercutting groove adjacent to the weld left unfilled by weld metal due</p> | <p>Any 02 defects 02 marks for each</p> |



MODEL ANSWER

SUMMER- 18 EXAMINATION

Subject Title: Processes Equipments

Subject Code: **17457**

to incorrect settings / procedure may make the weld weak.
Insufficient penetration:
Insufficient penetration of the weld metal in joints arises from too high heat input and / or too slow traverse of the welding torch (gas or electric).

- e) Advantages of spherical pressure vessel:
- Less space required for erection
 - High surface area as compared to cylindrical pressure vessel
 - Special types of fluids are stored in spherical vessels eg: LPG
 - Has capacity of holding higher volume of gases or liquids as compared to cylindrical vessel
 - Stress distribution is uniform throughout. Hence less chances of damage.

02 Marks for any 2 points

| Sr. No. | Parameters | Cylindrical pressure vessel | Spherical pressure vessel |
|---------|------------------|--|--|
| 1 | Stress | $\sigma_L = \frac{Pr}{2t}$ (Put unit values for P, r, t) | $\sigma_L = \frac{Pr}{2t}$ (Put unit values for P, r, t) |
| | | $\sigma_h = \frac{Pr}{t}$ (Put unit values for P, r, t) | $\sigma_h = \frac{Pr}{2t}$ (Put unit values for P, r, t) |
| 2 | Thickness | $t = \frac{Pr}{SE - 0.6P}$ (Put unit values for P, r, S, E) | $t = \frac{Pr}{2SE - 0.2P}$ (Put unit values for P, r, S, E) |
| 3 | Dilation | $\delta = \frac{Pr^2(2-\mu)}{2tE}$ (Put unit values for P, r, μ , t, E) | $\delta = \frac{Pr^2(1-\mu)}{2tE}$ (Put unit values for P, r, μ , t, E) |
| 4 | Storage capacity | $V = \pi r^2 h$ (Put unit values for r, h) | $V = \frac{4}{3} \pi r^3$ (Put unit value for r) |
| 5 | Surface area | $A = 2\pi rh + 2\pi r^2$ (Put unit values for r, h) | $A = 4\pi r^2$ (Put unit value for r) |

02 Marks for any 2 points

6 4/5 ✓

$$\frac{V_{cyl}}{A_{cyl}} =$$

$$\frac{V_{sph}}{A_{sph}} =$$

MODEL ANSWER

SUMMER- 18 EXAMINATION

Subject Title: Processes Equipments

Subject Code: **17457**



MODEL ANSWER

SUMMER- 18 EXAMINATION

Subject Title: Processes Equipments

Subject Code: **17457**

| | | |
|-----------|--|--|
| | <p>Pressure vessel consists of basic parts such as;</p> <ol style="list-style-type: none">1) Shell2) Head3) Nozzle4) Baffle Plates5) Supports (Rings)6) Piping, etc. | 01 Mark |
| ii | <p><u>The boiler mountings</u></p> <ul style="list-style-type: none">-Pressure Gauge-Safety Valve-Fusible Plug-Blow-Off Cock-Steam Stop Valve-Water Level Indicator <p><u>The boiler accessories</u></p> <ul style="list-style-type: none">-Economizer-Super heater-Air pre heater-Feed water pump-Steam injector | 02 Marks for any 4 points 02 Marks for any 4 points |
| b) | <p>Ultra High Pressure Vessels:</p> <p>Ultra high pressure vessels: Hydraulic and extrusion presses utilize very high fluid pressures to large forces, which in turn required extremely thick walled cylinders. In such cylinders hoop stress at the outside of the inside surface; hence the wall material is not used uniformly to its fullest stress and economic potential.</p> <p>Several design principles that have been successfully used to overcome this situation follow;</p> <ol style="list-style-type: none">1) Wedge principle2) Segment principle3) Cascade principle4) Yoke principle | 02 marks 02 marks |



MODEL ANSWER

SUMMER- 18 EXAMINATION

Subject Title: Processes Equipments

Subject Code: **17457**

c)

Types of Pressure Vessel Supports are:

- Skirt Support
 - a) Straight Type
 - b) Flared Type
- Saddle Support
 - a) Ring Type
 - b) Plate Type
- Brackets/ Lugs
- Base Plate
- Stiffening Rings

Support skirt:

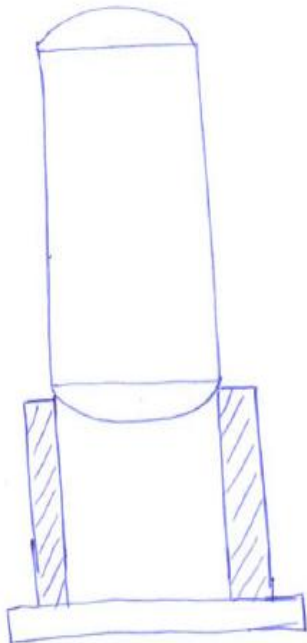

(i) straight type

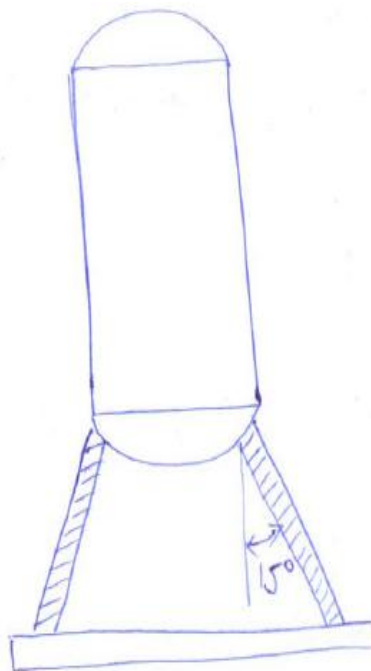

(ii) Flared type skirt support

02 Marks

03 Marks



MODEL ANSWER

SUMMER- 18 EXAMINATION

Subject Title: Processes Equipments

Subject Code: **17457**

| | |
|---|------------------------|
| <p>Tall vertical vessels are supported by cylindrical shell called as skirt. The skirt is a suitable supporting structure for tall vessels which are subjected to wind load, seismic load and other load. The skirt is welded to the bottom dish end from the outside of the shell. A bearing plate/ base plate/ support plate is attached to the bottom of the skirt. The plate is made to rest on a concrete foundation and is securely anchored to foundation by means of anchor bolts embedded in concrete to prevent overturning due to wind load or earthquake load. The commonly used materials for skirt supports are carbon steels.</p> <p>1) Straight type skirt support is used for tall vessels. The centre line of cylindrical skirt and shell are coincident. This type is more difficult to fabricate and is used mainly for high external loads, high design temperatures or cyclic operating temperatures. A good fit between the outside diameter of the shell and inside diameter of skirt is a must.</p> <p>2) Flared type skirt support is used for very high columns with high external moments. The angle of skirt is maximum 15°.</p> | <p>03 Marks</p> |
|---|------------------------|